



# VGR

ARTEFATOS DE CIMENTO

Rua General Irulegui Cunha, 497 – SP | Fone: (11) 2216-9772  
[vgrartefatosdecimento.com.br](http://vgrartefatosdecimento.com.br)



## **ELEMENTOS VAZADOS**

Caixilhos	03
Venezianas	10
Quadriculados	20
Decorativo	41



## **PRÉ-MOLDADOS**

Caixa para ar-condicionado	44
Bancos	47
Mesas com bancos	53
Grelhas e canaletas	58
Mourões	62
Miniguias	65



## **LINHA ECOLÓGICA**

Concregramas	67
Placa para Pisos	70



## **PRODUTOS DIVERSOS**

Capas para muros	72
Pingadeiras	72
Chapim	72

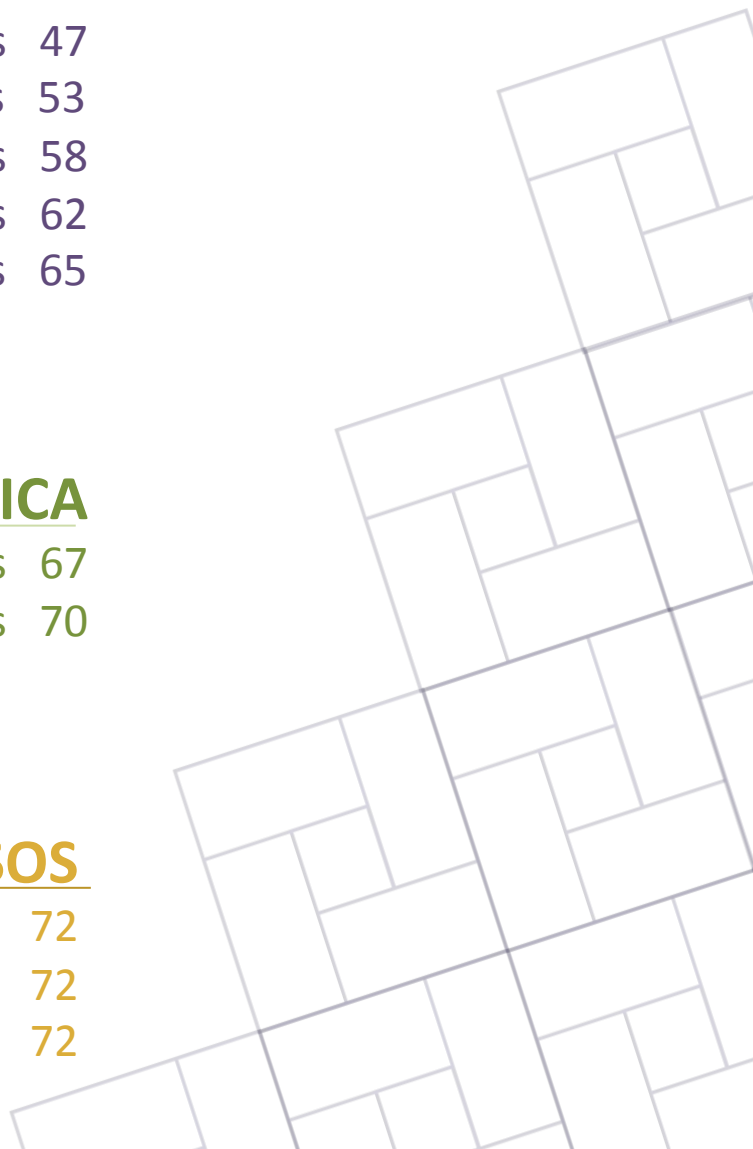



# ELEMENTOS VAZADOS

Caixilhos 03

Venezianas 10

Quadriculados 20

Decorativo 41



## ELEMENTOS VAZADOS CAIXILHOS



Sem Ventilação

Elemento vazado tipo caixilho,  
com rebaixo para um vidro.  
(vidros não inclusos)

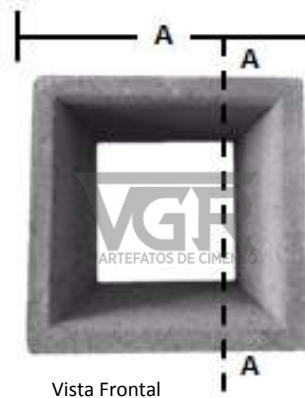

**1G**

MEDIDAS: 19 x 19 x 20 cm  
PEÇAS POR M<sup>2</sup>: 28  
PESO: 5 kg  
ARGAMASSA PRENSADA

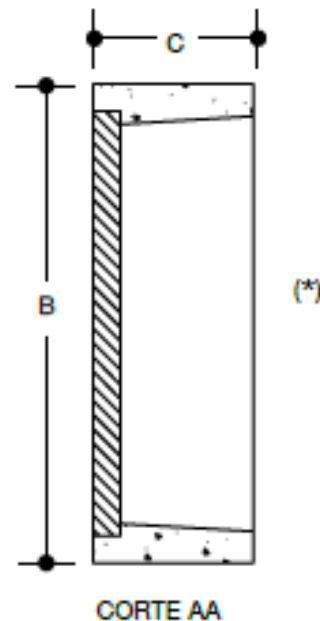
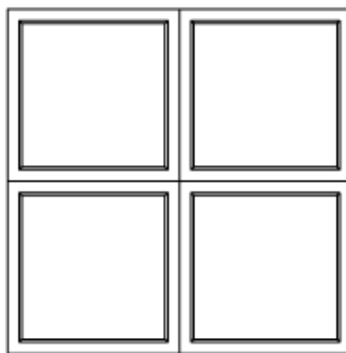

(\*) Vidros não inclusos



Sem Ventilação

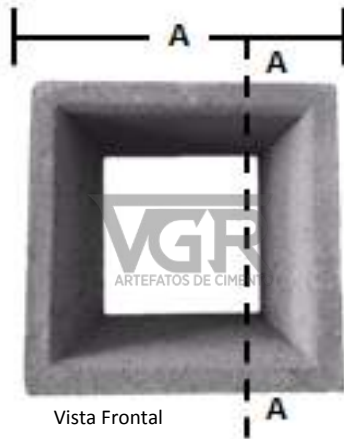

Vista Frontal

## ELEMENTOS VAZADOS CAIXILHOS

Elemento vazado tipo caixilho,  
com rebaixo para um vidro.  
(vidros não inclusos)

**1REB**

MEDIDAS: 19 x 19 x 10 cm  
PEÇAS POR M<sup>2</sup>: 28  
PESO: 2,6 kg  
ARGAMASSA Prensada

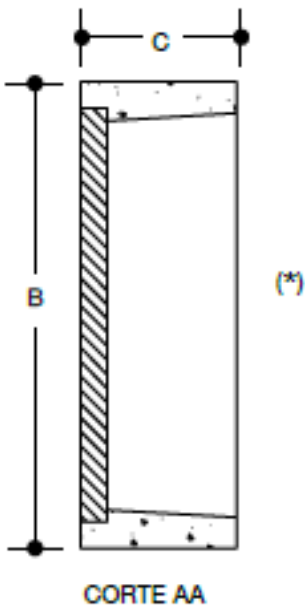

CORTE AA

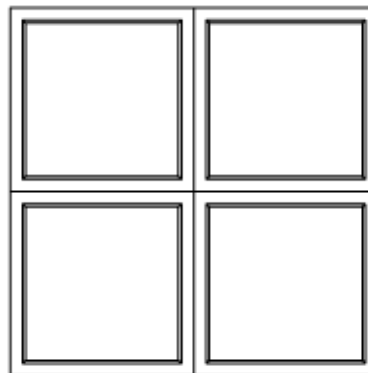

(\*) Vidros não inclusos

## ELEMENTOS VAZADOS CAIXILHOS

Elemento vazado tipo caixilho,  
com rebaixo para um vidro.  
(vidros não inclusos)

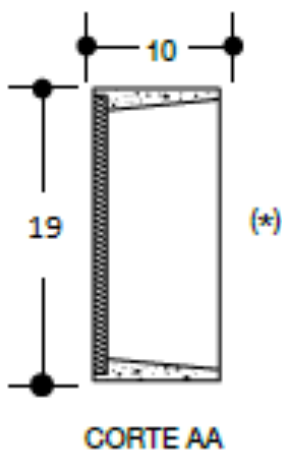

(\*) Vidros não inclusos

**2C**

MEDIDAS: 19 x 39 x 10 cm  
PEÇAS POR M<sup>2</sup>: 13,5  
PESO: 3,7 kg  
ARGAMASSA PRENSADA

**2D**

MEDIDAS: 20 x 40 x 15 cm  
PEÇAS POR M<sup>2</sup>: 13  
PESO: 6 kg  
ARGAMASSA PRENSADA

**2F**

MEDIDAS: 20 x 40 x 20 cm  
PEÇAS POR M<sup>2</sup>: 13  
PESO: 11,5 kg  
ARGAMASSA PRENSADA

## ELEMENTOS VAZADOS CAIXILHOS



Com Ventilação  
Permanente

Elemento vazado tipo caixilho  
para ventilação permanente,  
com rebaixo para um vidro e  
meio.  
(vidros não inclusos)

**4E**

MEDIDAS: 19 x 39 x 10 cm  
PEÇAS POR M<sup>2</sup>: 13,5  
PESO: 4,2 kg  
ARGAMASSA PRENSADA



Vista Frontal

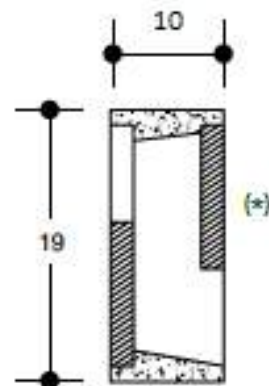
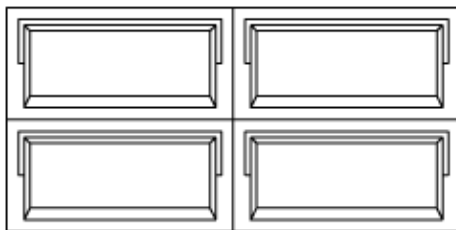

CORTE AA

(\*) Vidros não inclusos

## ELEMENTOS VAZADOS CAIXILHOS



Com Ventilação  
Permanente

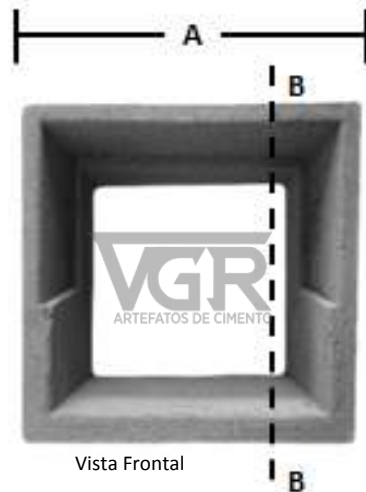

Vista Frontal

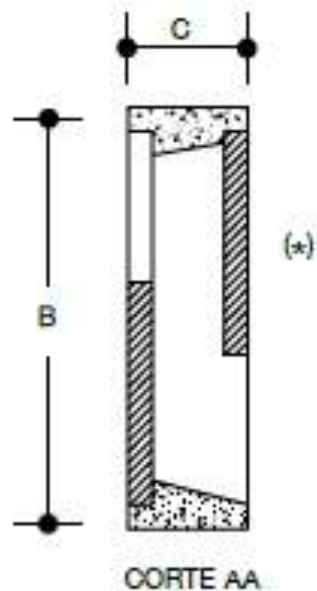
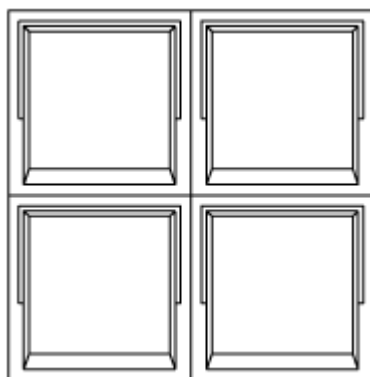

(\*) Vidros não inclusos

**17**

MEDIDAS: 30 x 30 x 10 cm  
PEÇAS POR M<sup>2</sup>: 11  
PESO: 4,8 kg  
ARGAMASSA PRENSADA

**17A**

MEDIDAS: 29 x 29 x 15 cm  
PEÇAS POR M<sup>2</sup>: 12  
PESO: 7,6 kg  
ARGAMASSA PRENSADA

**17B**

MEDIDAS: 29 x 29 x 20 cm  
PEÇAS POR M<sup>2</sup>: 12  
PESO: 9,5 kg  
ARGAMASSA PRENSADA



## ELEMENTOS VAZADOS CAIXILHOS

Elemento Vazado tipo caixilho sem ventilação, com rebaixo para um vidro. (vidros não inclusos)

**20**

MEDIDAS: 39 x 39 x 10 cm  
PEÇAS POR M<sup>2</sup>: 7  
PESO: 5 kg  
ARGAMASSA Prensada

**20B**

MEDIDAS: 59 x 59 x 20 cm  
PEÇAS POR M<sup>2</sup>: 3  
PESO: 24,5 kg  
ARGAMASSA Prensada

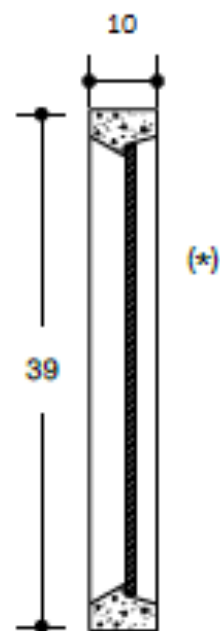

(\*)



Vista Frontal

CORTE AA

(\*) Vidros não inclusos



# ELEMENTOS VAZADOS

Caixilhos 03

Venezianas 10

Quadriculados 20

Decorativo 41



## ELEMENTOS VAZADOS VENEZIANAS

Elemento vazado tipo veneziana, com 8 lâminas.

**6**

MEDIDAS: 49 x 50 x 8 cm  
PEÇAS POR M<sup>2</sup>: 4  
PESO: 13 kg  
ARGAMASSA PRENSADA

**6A**

MEDIDAS: 40 x 50 x 8 cm  
PEÇAS POR M<sup>2</sup>: 5  
PESO: 12,8 kg  
ARGAMASSA PRENSADA

**6F**

MEDIDAS: 39 x 39 x 8 cm  
PEÇAS POR M<sup>2</sup>: 7  
PESO: 11,5 kg  
ARGAMASSA PRENSADA

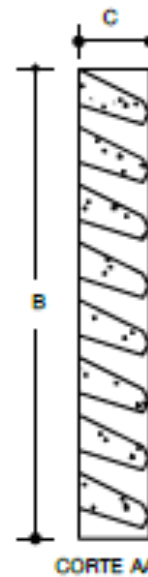
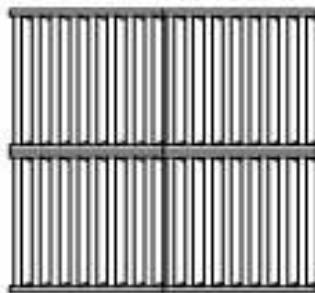

## ELEMENTOS VAZADOS VENEZIANAS

Elemento vazado tipo veneziana, com 6 lâminas.

**6G**

MEDIDAS: 39 x 39 x 8 cm  
PEÇAS POR M<sup>2</sup>: 7  
PESO: 9,5 kg  
ARGAMASSA PRENSADA

**6B**

MEDIDAS: 30 x 30 x 7 cm  
PEÇAS POR M<sup>2</sup>: 11  
PESO: 5,1 kg  
ARGAMASSA PRENSADA



CORTE AA

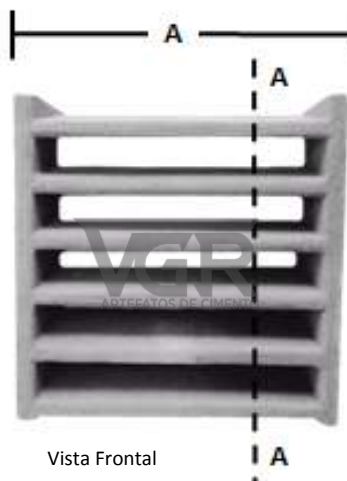

Vista Frontal

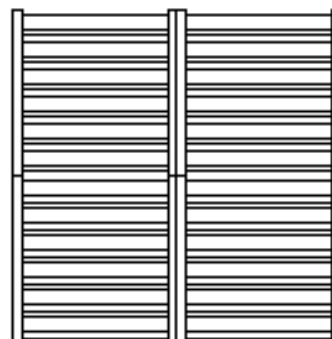
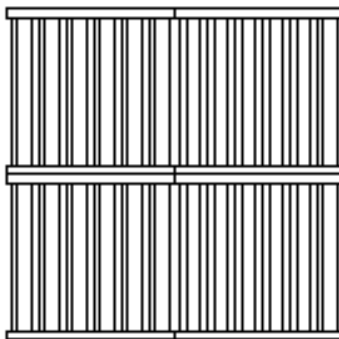

## ELEMENTOS VAZADOS VENEZIANAS



Elemento Vazado veneziana,  
com 7 lâminas.

**6E**

MEDIDAS: 39 x 39 x 8 cm  
PEÇAS POR M<sup>2</sup>: 7  
PESO: 11,4 kg  
ARGAMASSA PRENSADA

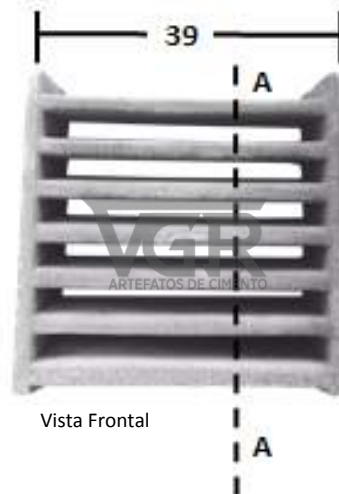

Vista Frontal

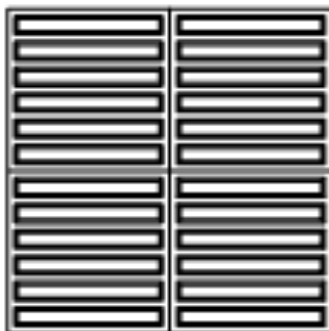

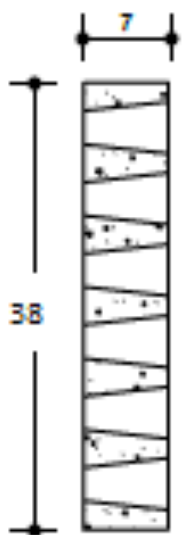

CORTE AA

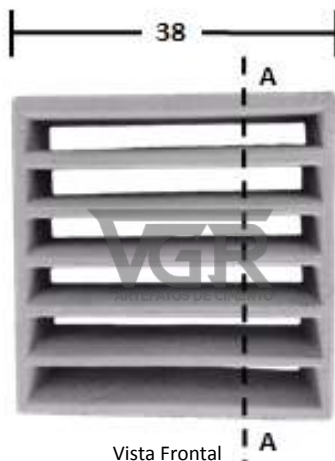

Vista Frontal

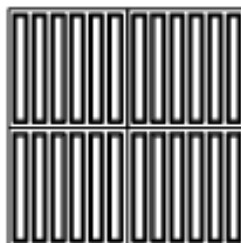
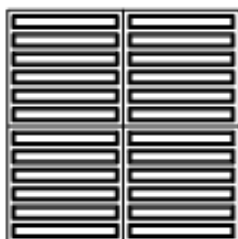

## ELEMENTOS VAZADOS VENEZIANAS

7: Elemento Vazado tipo paralelo, com 7 lâminas.

7B: Elemento Vazado tipo paralelo, com 7 lâminas levemente inclinadas.

**7**

**MEDIDAS: 38 x 38 x 7 cm**  
PEÇAS POR M<sup>2</sup>: 7  
PESO: 7,6 kg  
ARGAMASSA PRENSADA

**7B**

**MEDIDAS: 39x 39 x 7 cm**  
PEÇAS POR M<sup>2</sup>: 7  
PESO: 7,6 kg  
ARGAMASSA PRENSADA

## ELEMENTOS VAZADOS VENEZIANAS



Vista Frontal



Elemento Vazado tipo veneziana, com 1 lâmina.

9

MEDIDAS: 39 x 22 x 15 cm  
PEÇAS POR M<sup>2</sup>: 12  
PESO: 7,6 kg  
ARGAMASSA PRENSADA

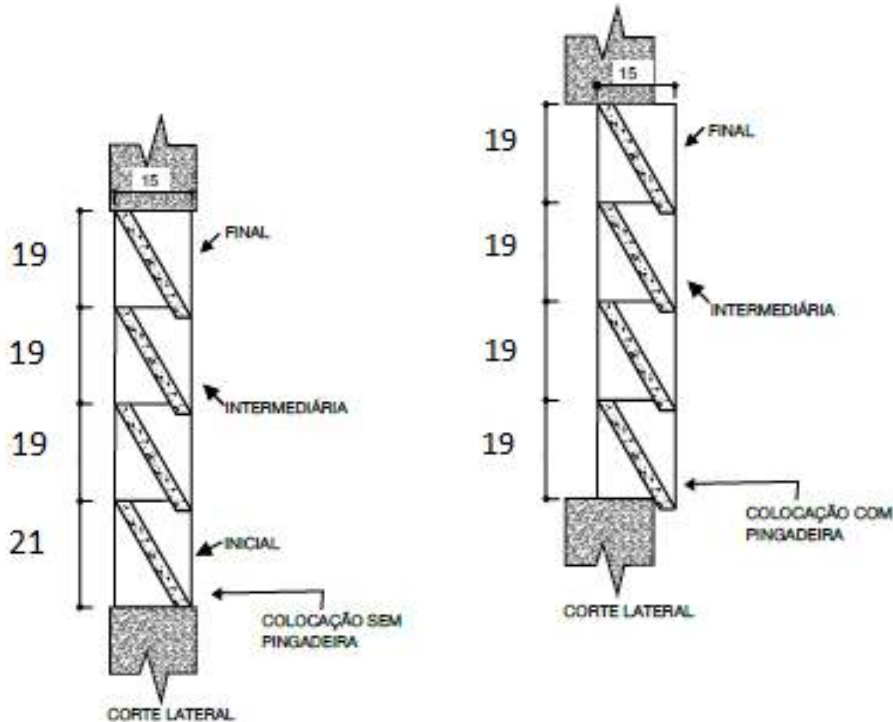



## ELEMENTOS VAZADOS VENEZIANAS

Elemento vazado tipo veneziana, com 7 lâminas.

**10**

MEDIDAS: 35 x 50 x 8 cm  
PEÇAS POR M<sup>2</sup>: 6  
PESO: 10 kg  
ARGAMASSA PRENSADA



Vista Frontal



CORTE AA

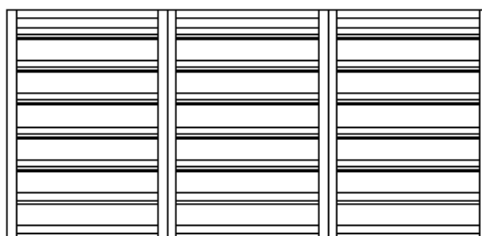



## ELEMENTOS VAZADOS VENEZIANAS

11: Elemento vazado tipo veneziana, com uma lâmina.

11B: Elemento vazado tipo veneziana, com 4 lâminas.



Vista Frontal

11

11B

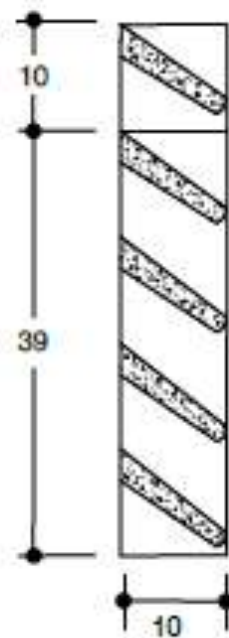

CORTE AA

**11**

MEDIDAS: 39 x 10 x 10 cm  
PEÇAS POR M<sup>2</sup>: 26  
PESO: 2,9 kg  
ARGAMASSA PRENSADA

**11B**

MEDIDAS: 39 x 39 x 10 cm  
PEÇAS POR M<sup>2</sup>: 7  
PESO: 11,0 kg  
ARGAMASSA PRENSADA



11

11B

## ELEMENTOS VAZADOS VENEZIANAS



11A



11A

11A: Elemento vazado tipo veneziana, com uma lâmina.

11D: Elemento vazado tipo veneziana, com 4 lâminas.



11D

Vista Frontal

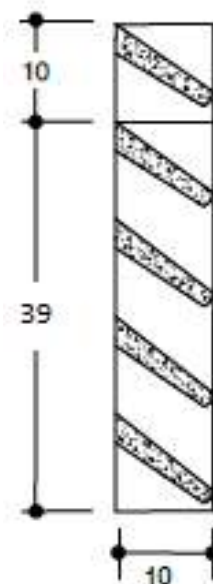

CORTE AA

### 11A

MEDIDAS: 29 x 10 x 10 cm  
PEÇAS POR M<sup>2</sup>: 35  
PESO: 2,4 kg  
ARGAMASSA PRENSADA

### 11D

MEDIDAS: 29 x 39 x 10 cm  
PEÇAS POR M<sup>2</sup>: 9  
PESO: 10,9 kg  
ARGAMASSA PRENSADA



11A

11D

## ELEMENTOS VAZADOS VENEZIANAS



Elemento Vazado tipo veneziana,  
com 7 lâminas.

**79A**

MEDIDAS: 60 x 45 x 8 cm  
PEÇAS POR M<sup>2</sup>: 3,7  
PESO: 12,5 kg  
ARGAMASSA PRENSADA

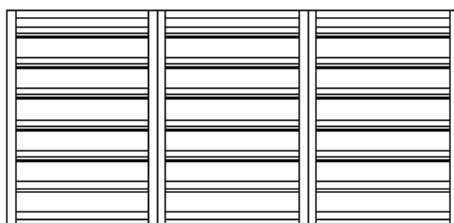



## **ELEMENTOS VAZADOS**

---

Caixilhos 03

Venezianas 10

Quadriculados 20

Decorativo 41



## ELEMENTOS VAZADOS QUADRICULADOS

Elemento Vazado quadriculado,  
com 1 furo.

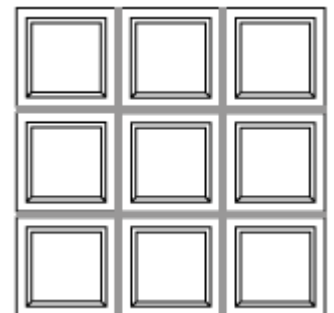
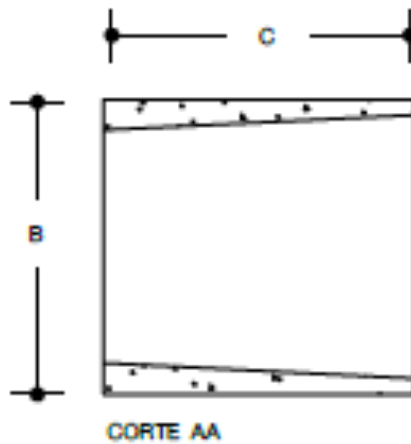
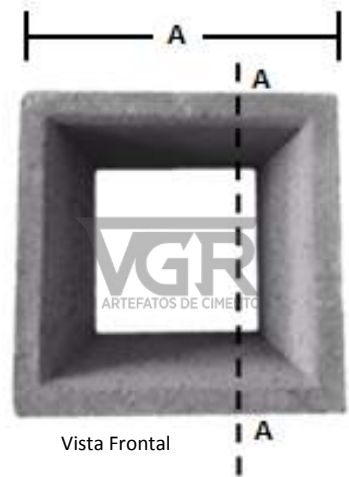

**1**

MEDIDAS: 19 x 19 x 10 cm  
PEÇAS POR M<sup>2</sup>: 28  
PESO: 2,6 kg  
ARGAMASSA PRENSADA

**1A**

MEDIDAS: 20 x 20 x 15 cm  
PEÇAS POR M<sup>2</sup>: 25  
PESO: 4 kg  
ARGAMASSA PRENSADA

**1B**

MEDIDAS: 19 x 19 x 20 cm  
PEÇAS POR M<sup>2</sup>: 28  
PESO: 5,2 kg  
ARGAMASSA PRENSADA

**1Q**

MEDIDAS: 10 x 10 x 10 cm  
PEÇAS POR M<sup>2</sup>: 100  
PESO: 0,8 kg  
ARGAMASSA PRENSADA

## ELEMENTOS VAZADOS QUADRICULADOS

Elemento Vazado quadriculado,  
com 1 furo.

**1C**

MEDIDAS: 25 x 25 x 10 cm  
PEÇAS POR M<sup>2</sup>: 16  
PESO: 6,5 kg  
ARGAMASSA PRENSADA

**1D**

MEDIDAS: 14 x 12 x 10 cm  
PEÇAS POR M<sup>2</sup>: 60  
PESO: 1,3 kg  
ARGAMASSA PRENSADA

**1E**

MEDIDAS: 15 x 15 x 10 cm  
PEÇAS POR M<sup>2</sup>: 45  
PESO: 1,6 kg  
ARGAMASSA PRENSADA

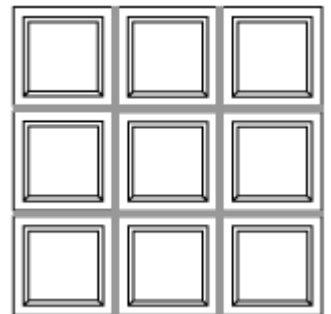
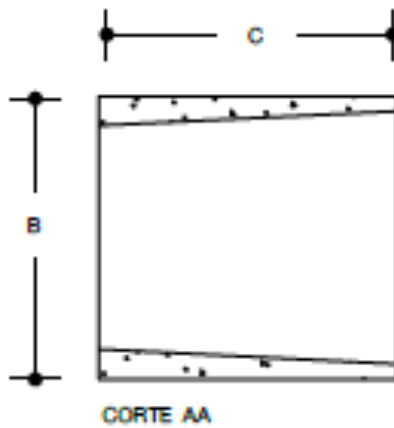

## ELEMENTOS VAZADOS QUADRICULADOS



Elemento Vazado com 1 furo  
retangular.

**2**

MEDIDAS: 19 x 39 x 10 cm  
PEÇAS POR M<sup>2</sup>: 13  
PESO: 4,3 kg  
ARGAMASSA PRENSADA

**2A**

MEDIDAS: 19 x 39 x 15 cm  
PEÇAS POR M<sup>2</sup>: 13  
PESO: 6,1 kg  
ARGAMASSA PRENSADA

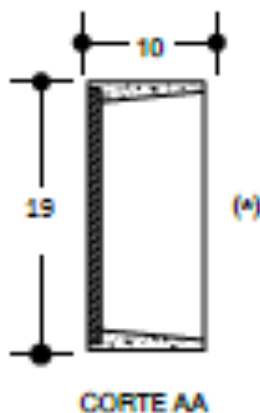



## ELEMENTOS VAZADOS QUADRICULADOS

Elemento Vazado quadriculado,  
com 9 furos.

**3**

MEDIDAS: 33,5 x 33,5 x 7 cm  
PEÇAS POR M<sup>2</sup>: 9  
PESO: 6,3 kg  
ARGAMASSA PRENSADA

**3B**

MEDIDAS: 39,5 x 39,5 x 8 cm  
PEÇAS POR M<sup>2</sup>: 6  
PESO: 10,1 KG  
ARGAMASSA PRENSADA

**3C**

MEDIDAS: 30 x 30 x 6 cm  
PEÇAS POR M<sup>2</sup>: 11  
PESO: 4,6 KG  
ARGAMASSA PRENSADA

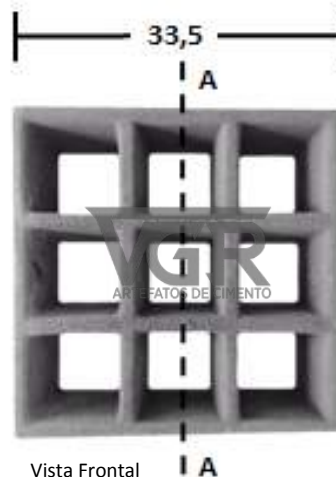

Vista Frontal

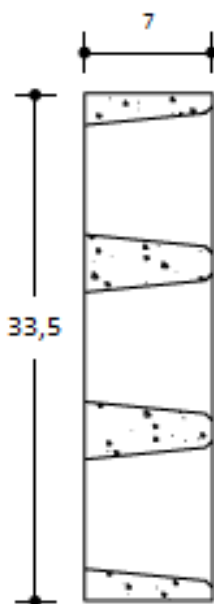

CORTE AA

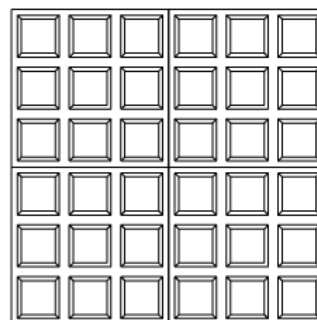



## ELEMENTOS VAZADOS QUADRICULADOS



Elemento Vazado quadriculado,  
com 9 furos.

**3A**

MEDIDAS: 39,5 x 39,5 x 10 cm  
PEÇAS POR M<sup>2</sup>: 7  
PESO: 11,7 kg  
ARGAMASSA PRENSADA

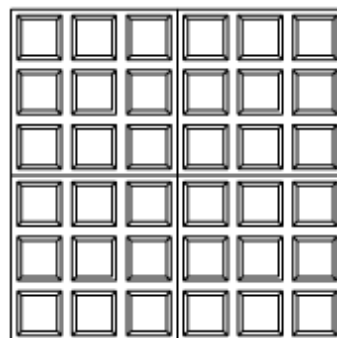
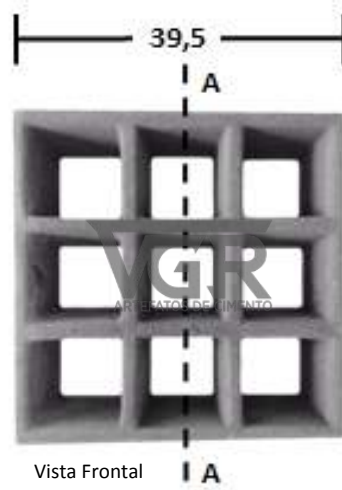
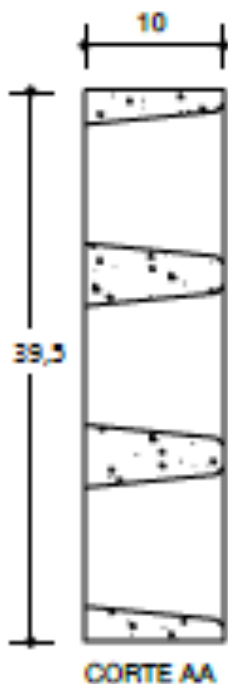

## ELEMENTOS VAZADOS QUADRICULADOS

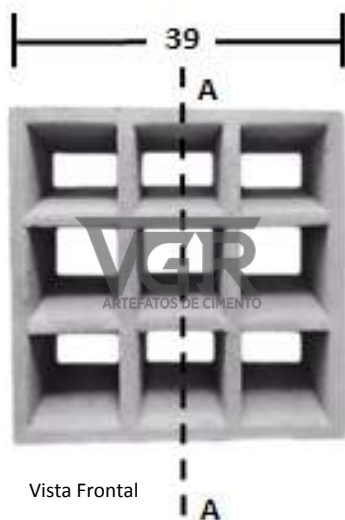

Vista Frontal



**3A-INCL**

MEDIDAS: 39 x 39 x 10 cm  
PEÇAS POR M<sup>2</sup>: 7  
PESO: 12,5 kg  
ARGAMASSA PRENSADA

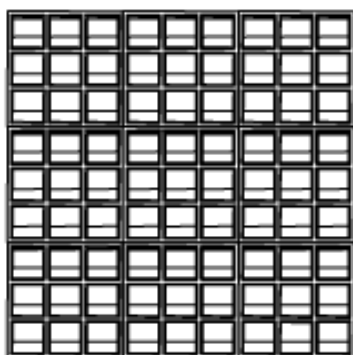

## ELEMENTOS VAZADOS QUADRICULADOS

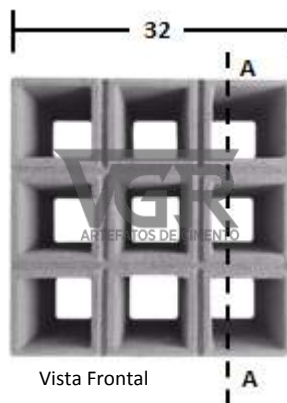

Elemento vazado quadriculado  
com 9 furos retos com friso.

**3D**

MEDIDAS: 32 x 32 x 10 cm  
PEÇAS POR M<sup>2</sup>: 10  
PESO: 10,2 kg  
ARGAMASSA PRENSADA

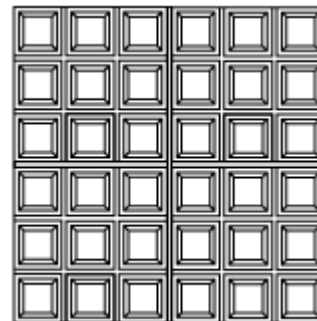
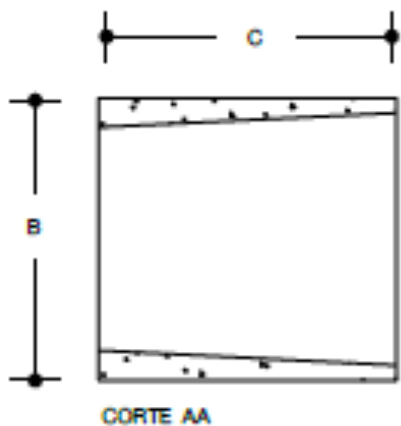
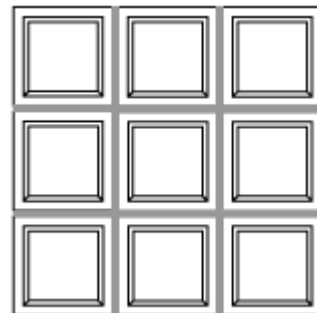
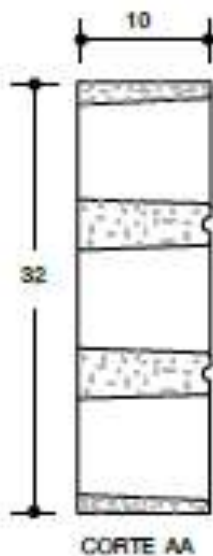

## ELEMENTOS VAZADOS QUADRICULADOS



Elemento vazado quadriculado com 6 furos retos com friso.

**3F**

MEDIDAS: 21 x 32 x 10 cm  
PEÇAS POR M<sup>2</sup>: 15  
PESO: 6,5 kg  
ARGAMASSA PRENSADA

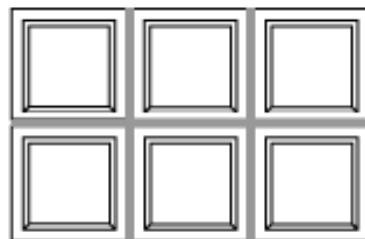
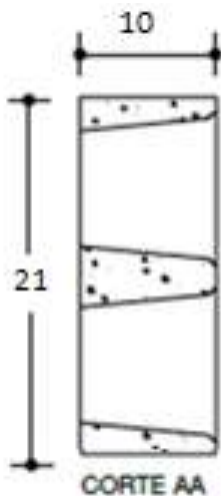
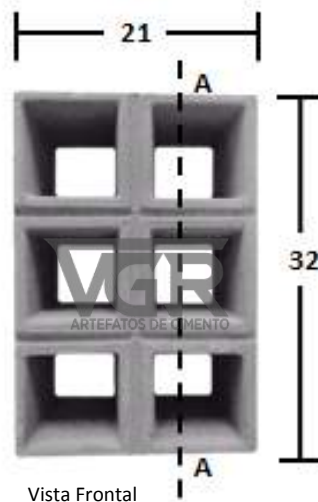



## ELEMENTOS VAZADOS QUADRICULADOS

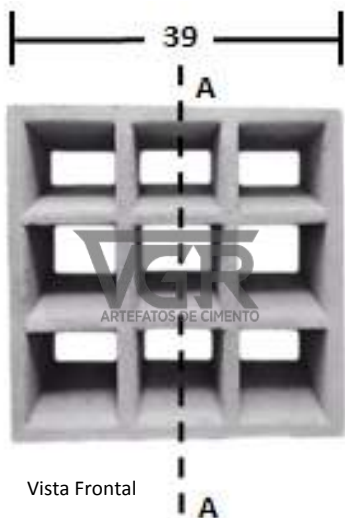

Vista Frontal

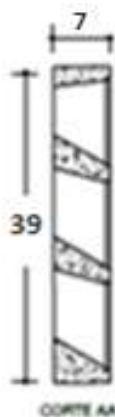
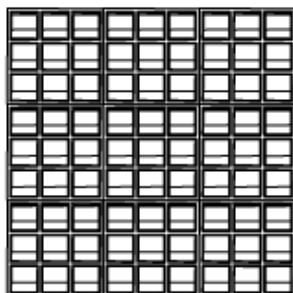

Elemento Vazado quadriculado,  
com 9 furos, com as lâminas  
horizontais em veneziana.

**3V**

**MEDIDAS: 39 x 39 x 7 cm**  
PEÇAS POR M<sup>2</sup>: 7  
PESO: 9,2 kg  
ARGAMASSA PRENSADA

## ELEMENTOS VAZADOS QUADRICULADOS

Elemento Vazado quadriculado,  
com 16 furos.

**4**

**MEDIDAS: 25 x 25 x 6 cm**  
PEÇAS POR M<sup>2</sup>: 16  
PESO: 3,9 kg  
ARGAMASSA PRENSADA

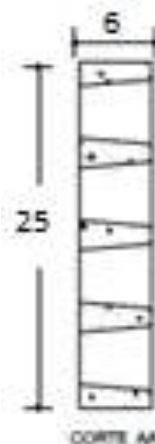
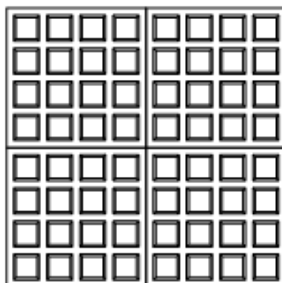
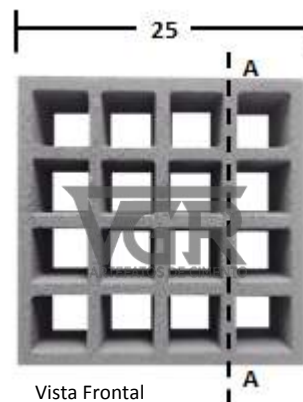

## ELEMENTOS VAZADOS QUADRICULADOS

Elemento Vazado quadriculado, com 16 furos.

**4A**

MEDIDAS: 29 x 29 x 6 cm  
 PEÇAS POR M<sup>2</sup>: 12  
 PESO: 4,6 kg  
 ARGAMASSA Prensada

**4B**

MEDIDAS: 33 x 33 x 10 cm  
 PEÇAS POR M<sup>2</sup>: 9  
 PESO: 11,3 KG  
 ARGAMASSA Prensada

**4E**

MEDIDAS: 39 x 39 x 7 cm  
 PEÇAS POR M<sup>2</sup>: 7  
 PESO: 8,5 kg  
 ARGAMASSA Prensada

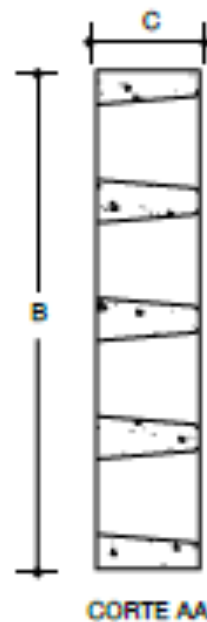
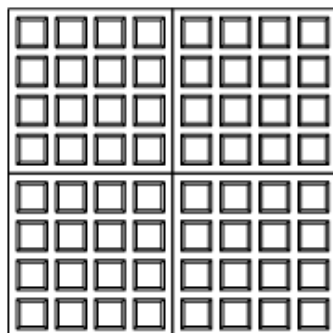
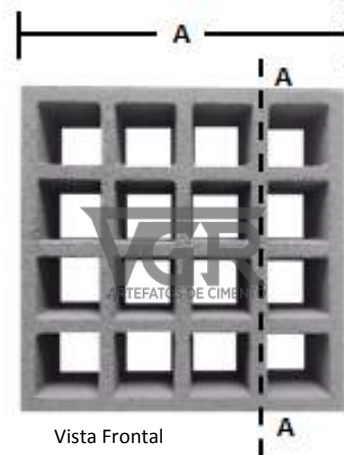



## ELEMENTOS VAZADOS QUADRICULADOS

Elemento Vazado quadriculado,  
com 16 furos.

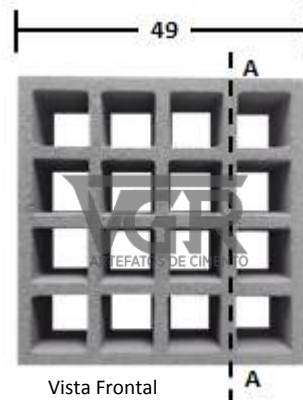

**4D**

MEDIDAS: 49 x 49 x 7 cm  
PEÇAS POR M<sup>2</sup>: 4  
PESO: 13,8 kg  
ARGAMASSA PRENSADA

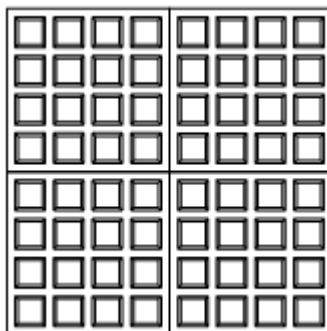

CORTE AA





## ELEMENTOS VAZADOS QUADRICULADOS

Elemento Vazado quadriculado,  
com 16 furos inclinados.

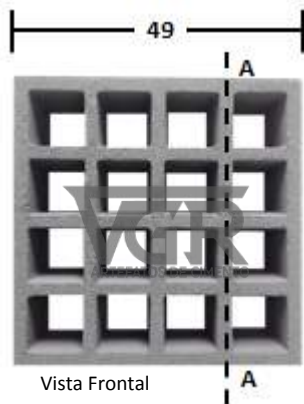

**4D-INCL**

MEDIDAS: 49 x 49 x 7 cm  
PEÇAS POR M<sup>2</sup>: 4  
PESO: 16 kg  
ARGAMASSA PRENSADA

## ELEMENTOS VAZADOS QUADRICULADOS



4P

4Q

Elemento Vazado quadriculado com friso, com 16 furos.

4P

MEDIDAS: 39 x 39 x 10 cm  
PEÇAS POR M<sup>2</sup>: 7  
PESO: 15 kg  
ARGAMASSA PRENSADA

4Q

MEDIDAS: 39 x 39 x 7 cm  
PEÇAS POR M<sup>2</sup>: 7  
PESO: 9,5 kg  
ARGAMASSA PRENSADA

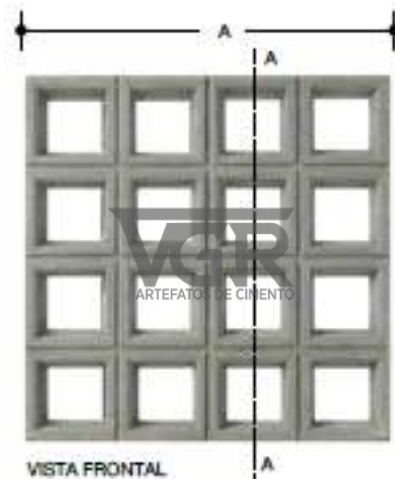
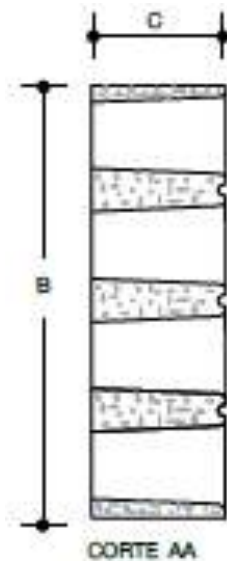

4P

4Q

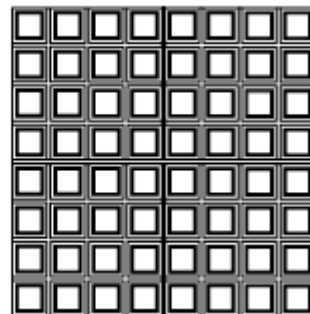

## ELEMENTOS VAZADOS QUADRICULADOS

Elemento Vazado quadriculado,  
com 25 furos.

**5**

MEDIDAS: 39,5 x 39,5 x 7 cm  
PEÇAS POR M<sup>2</sup>: 7  
PESO: 9,9 kg  
ARGAMASSA PRENSADA

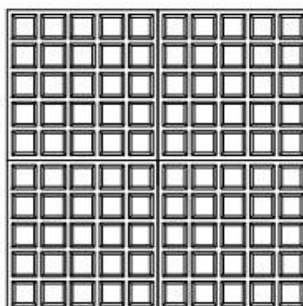
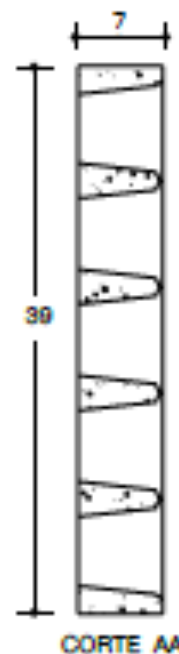
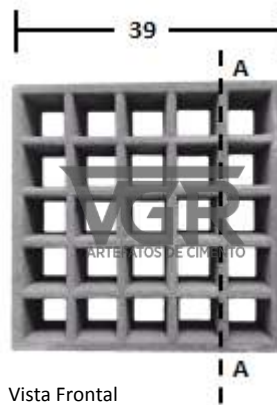



Vista Frontal



CORTE AA

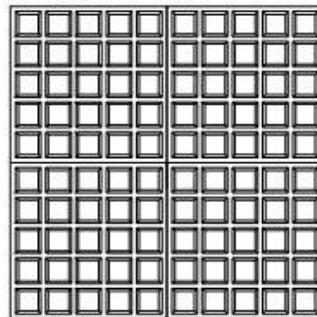

## ELEMENTOS VAZADOS QUADRICULADOS

Elemento vazado quadriculado,  
com 25 furos.

**5A**

MEDIDAS: 49 x 49 x 8 cm  
PEÇAS POR M<sup>2</sup>: 4  
PESO: 13,8 kg  
ARGAMASSA Prensada

## ELEMENTOS VAZADOS QUADRICULADOS



Elemento vazado quadriculado,  
com 25 furos inclinados.

**5B**

MEDIDAS: 39 x 39 x 8 cm  
PEÇAS POR M<sup>2</sup>: 7  
PESO: 12,1 kg  
ARGAMASSA PRENSADA



Vista Frontal

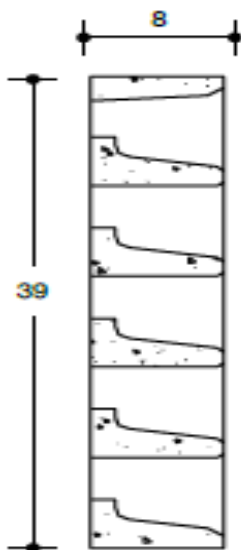

CORTE AA

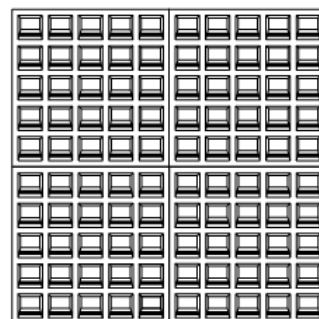

## ELEMENTOS VAZADOS QUADRICULADOS



Elemento Vazado quadriculado, com 16 furos, com as lâminas horizontais em veneziana.

**8**

MEDIDAS: 39 x 39 x 7 cm  
PEÇAS POR M<sup>2</sup>: 7  
PESO: 9,9 kg  
ARGAMASSA PRENSADA

**8A**

MEDIDAS: 39 x 39 x 10 cm  
PEÇAS POR M<sup>2</sup>: 7  
PESO: 13,8 KG  
ARGAMASSA PRENSADA

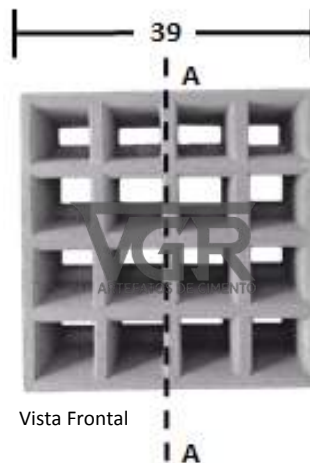

Vista Frontal

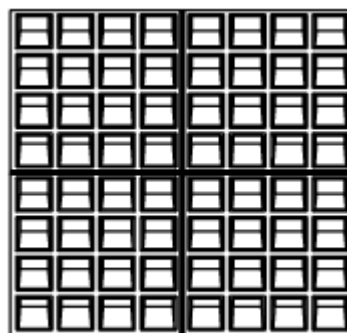
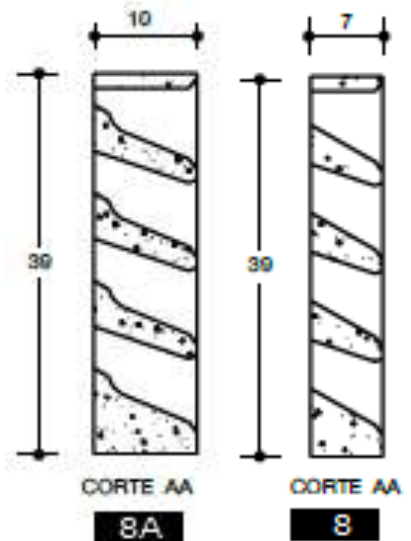



## ELEMENTOS VAZADOS QUADRICULADOS

Elemento vazado quadriculado com 15 furos.

**22**

MEDIDAS: 32 x 48 x 10 cm  
 PEÇAS POR M<sup>2</sup>: 6,5  
 PESO: 13 kg  
 ARGAMASSA PRENSADA

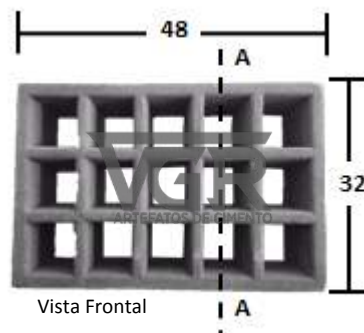

## ELEMENTOS VAZADOS QUADRICULADOS

Elemento vazado com 4 furos retos.

**23**

MEDIDAS: 39 x 39 x 15 cm  
 PEÇAS POR M<sup>2</sup>: 7  
 PESO: 15 kg  
 ARGAMASSA PRENSADA

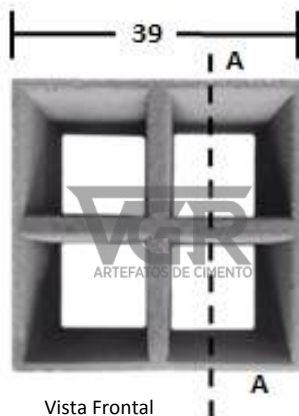

## ELEMENTOS VAZADOS QUADRICULADOS

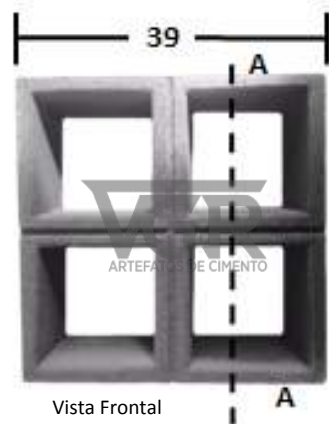

Elemento Vazado quadriculado,  
4 furos com friso.

**23A**

MEDIDAS: 39 x 39 x 10 cm  
PEÇAS POR M<sup>2</sup>: 7  
PESO: 13,7 kg  
ARGAMASSA PRENSADA

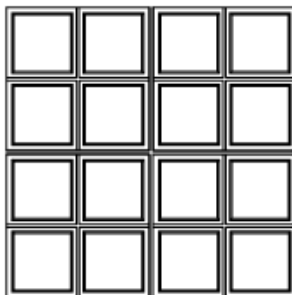





# **ELEMENTOS VAZADOS**

---

Caixilhos 03

Venezianas 10

Quadriculados 20

**Decorativo 41**



## ELEMENTOS VAZADOS DECORATIVO

Elemento vazado com 1 furo circular.

**13**

MEDIDAS: 30 x 30 x 10 cm  
PEÇAS POR M<sup>2</sup>: 11  
PESO: 10 kg  
ARGAMASSA PRENSADA



Vista Frontal

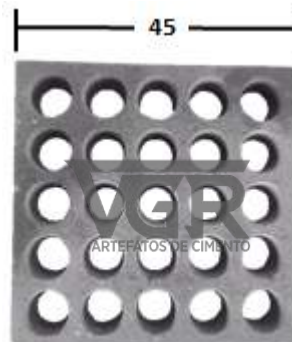

Vista Frontal

## ELEMENTOS VAZADOS DECORATIVO

Elemento vazado com 25 furos circulares.

**15**

MEDIDAS: 45 x 45 x 5 cm  
PEÇAS POR M<sup>2</sup>: 5  
PESO: 11,7 kg  
ARGAMASSA PRENSADA

## ELEMENTOS VAZADOS DECORATIVO



Elemento vazado decorativo.

**16**

MEDIDAS: 29 x 29 x 7 cm  
PEÇAS POR M<sup>2</sup>: 12  
PESO: 4,1 kg  
ARGAMASSA PRENSADA





## PRÉ-MOLDADOS

Caixa para ar-condicionado 44

Bancos 47

Mesas com bancos 53

Grelhas e canaletas 58

Mourões 62

Miniguias 65

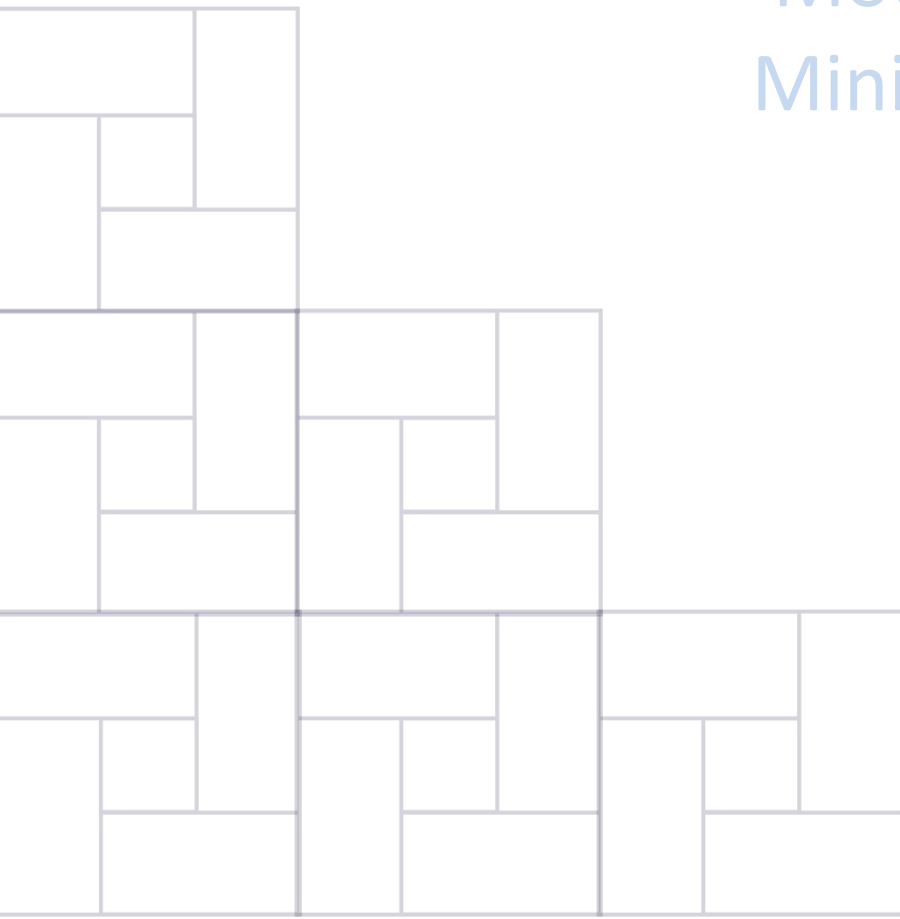

## PRÉ-MOLDADOS CAIXA PARA AR CONDICIONADO

Caixa para abrigo de Ar Condicionado.

### CAC1

MEDIDAS INTERNAS: 53 x 39 x 59 cm  
 MEDIDAS EXTERNAS: 61 x 47 x 63 cm  
 PESO: 85 kg  
 CONCRETO COM FERRAGEM

### CAC2

MEDIDAS INTERNAS: 69 x 49 x 69 cm  
 MEDIDAS EXTERNAS: 78 x 58 x 73,5 cm  
 PESO: 150 kg  
 CONCRETO COM FERRAGEM

### CAC3

MEDIDAS INTERNAS: 72 x 43 x 72 cm  
 MEDIDAS EXTERNAS: 81 x 52 x 76,5 cm  
 PESO: 150 kg  
 CONCRETO COM FERRAGEM

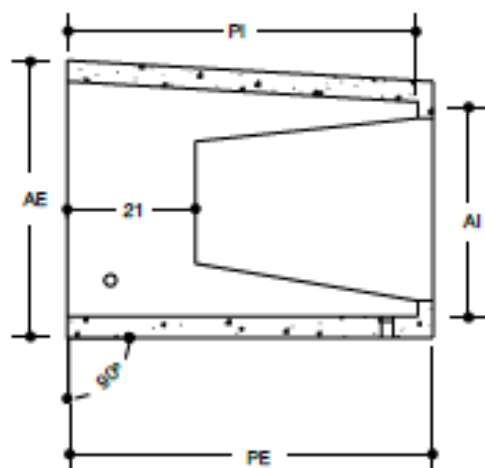
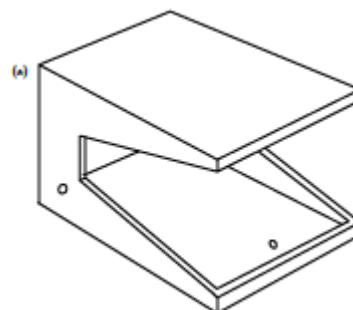
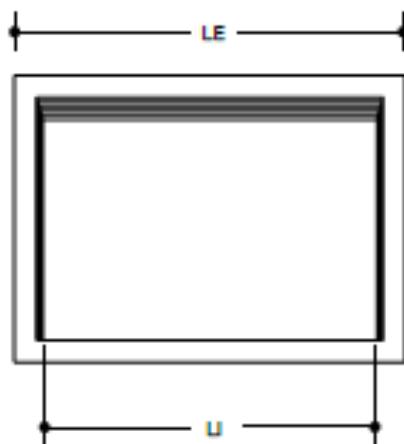



## PRÉ-MOLDADOS

---

Caixa para ar-condicionado 44

Bancos 47

Mesas com bancos 53

Grelhas e canaletas 58

Mourões 62

Miniguias 65

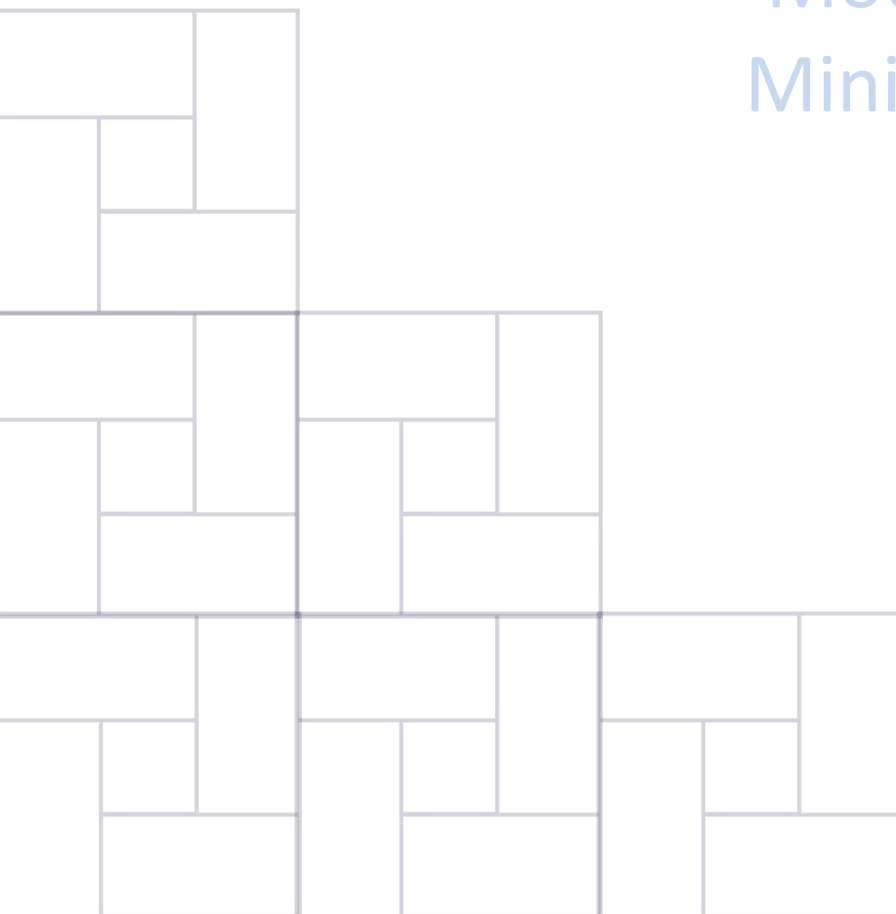

## PRÉ-MOLDADOS BANCOS

Banco pré-moldado ondulado, em concreto com ferragem, com 3, 4 ou 5 lugares.

### B1-150

MEDIDAS: 150 x 50 x 55 cm  
PESO: 140 kg  
CONCRETO COM FERRAGEM

### B1-200

MEDIDAS: 200 x 50 x 55 cm  
PESO: 180 kg  
CONCRETO COM FERRAGEM

### B1-250

MEDIDAS: 250 x 50 x 55 cm  
PESO: 230 kg  
CONCRETO COM FERRAGEM

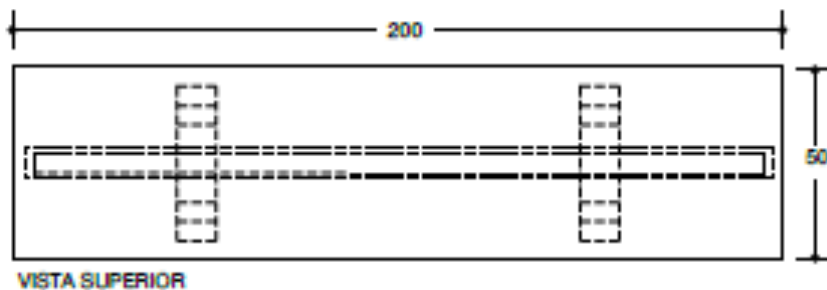
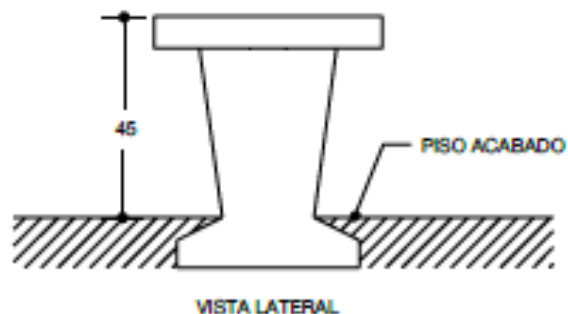
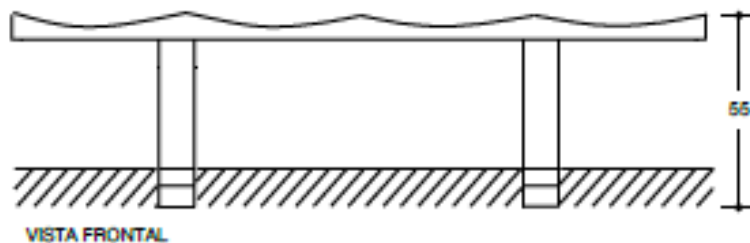

(\*) Todos os cantos são arredondados



## PRÉ-MOLDADOS BANCOS

Banco reto pré-moldado em concreto, com tampo liso e pés angulados.

### B2

MEDIDAS: 100 x 45 x 45 cm  
PESO: 120 kg  
CONCRETO COM FERRAGEM

### B2-150

MEDIDAS: 150 x 45 x 45 cm  
PESO: 180 kg  
CONCRETO COM FERRAGEM

### B2-200

MEDIDAS: 200 x 45 x 45 cm  
PESO: 220 kg  
CONCRETO COM FERRAGEM

### B2-300

MEDIDAS: 300 x 45 x 45 cm  
PESO: 320 kg  
CONCRETO COM FERRAGEM

### B2-400

MEDIDAS: 400 x 45 x 45 cm  
PESO: 400 kg  
CONCRETO COM FERRAGEM

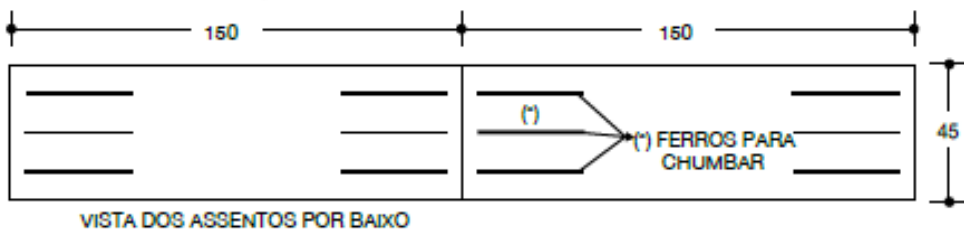
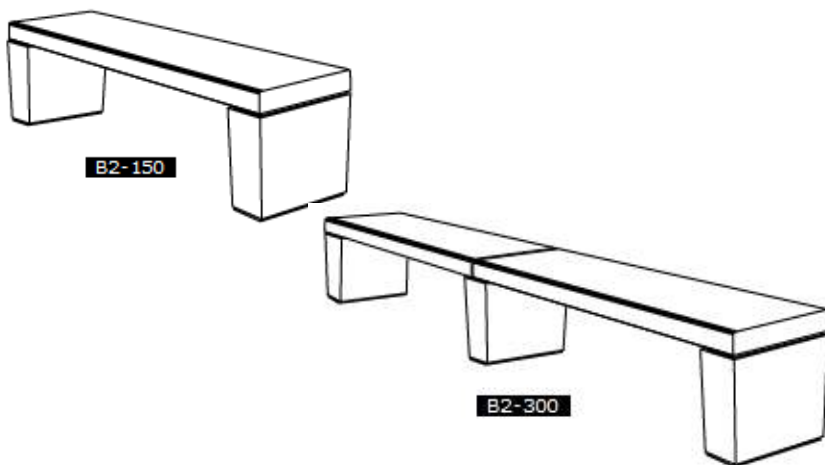

VISTA DOS ASSENTOS POR BAIXO

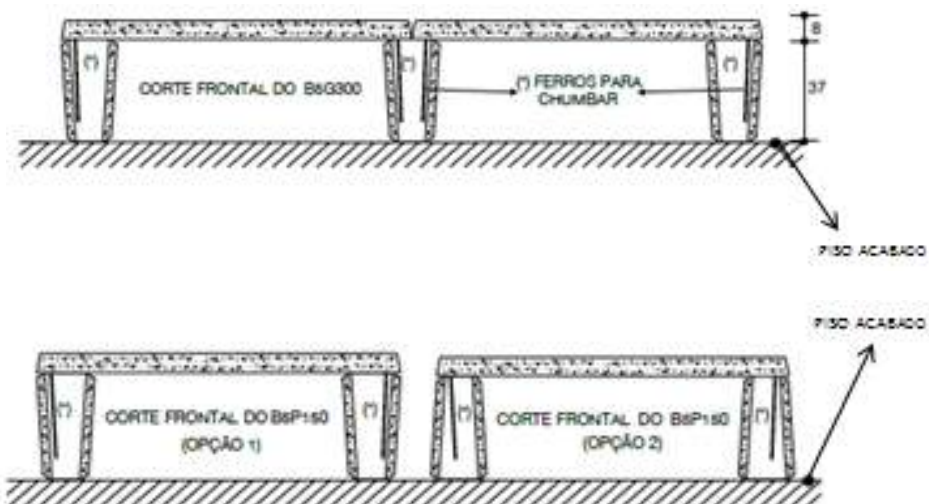

\* Todos os cantos são arredondados.

\* OBS: Os assentos e pés são fornecidos separadamente e chumbados posteriormente pela obra.

## PRÉ-MOLDADOS BANCOS

Banco pré-moldado em concreto com ferragem e pés curvos.

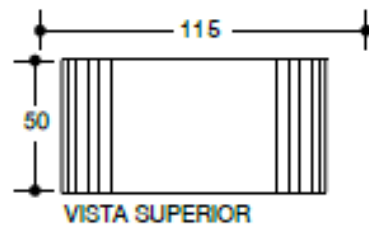

**B3-115**

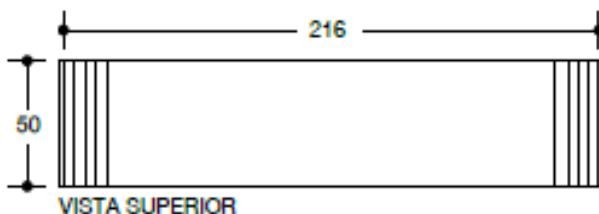

**B3-216**

### B3-115

MEDIDAS: 115 x 50 x 45 cm  
PESO: 140 kg  
CONCRETO COM FERRAGEM

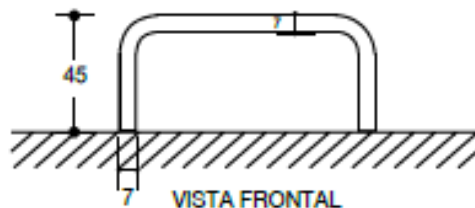

### B3-216

MEDIDAS: 216 x 50 x 45 cm  
PESO: 240 kg  
CONCRETO COM FERRAGEM

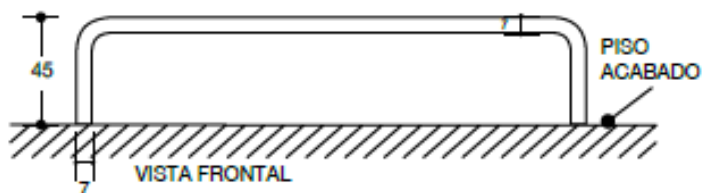

- (\*) Todos os cantos são arredondados
- (\*) Parafusos não inclusos
- (\*) Próprios para montagem modular

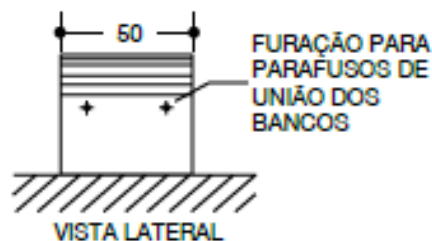

## PRÉ-MOLDADOS BANCOS

Banco pré-moldado em concreto  
no formato cubo.

**BC1**

MEDIDAS: 40 x 40 x 40 cm  
PESO: 60 kg  
CONCRETO COM FERRAGEM

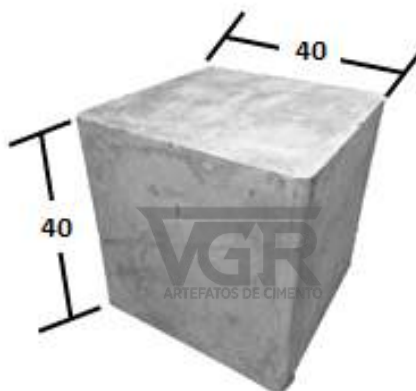

## PRÉ-MOLDADOS BANCOS

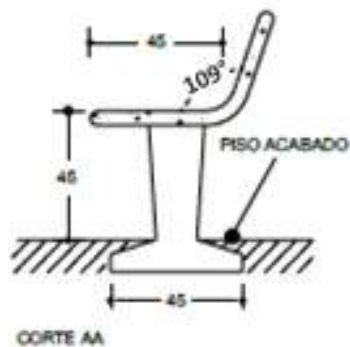
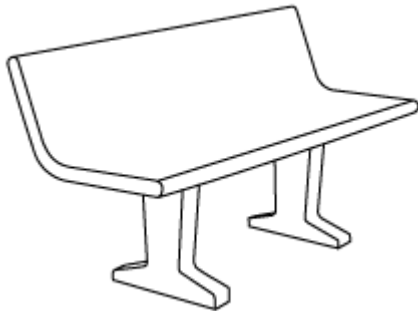

Banco curvo com encosto e pés integrados em concreto.

### BCURVO1

MEDIDAS: 180 x 64 x 89 cm  
PESO: 241 kg  
CONCRETO COM FERRAGEM

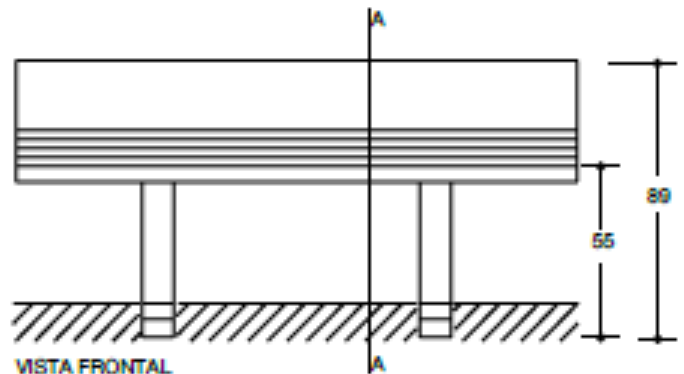
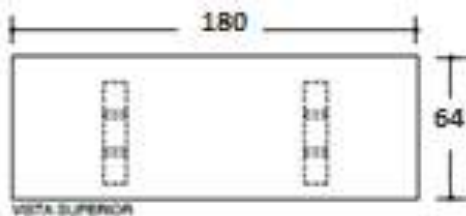



## PRÉ-MOLDADOS

---

Caixa para ar-condicionado 44

Bancos 47

Mesas com bancos 53

Grelhas e canaletas 58

Mourões 62

Miniguias 65

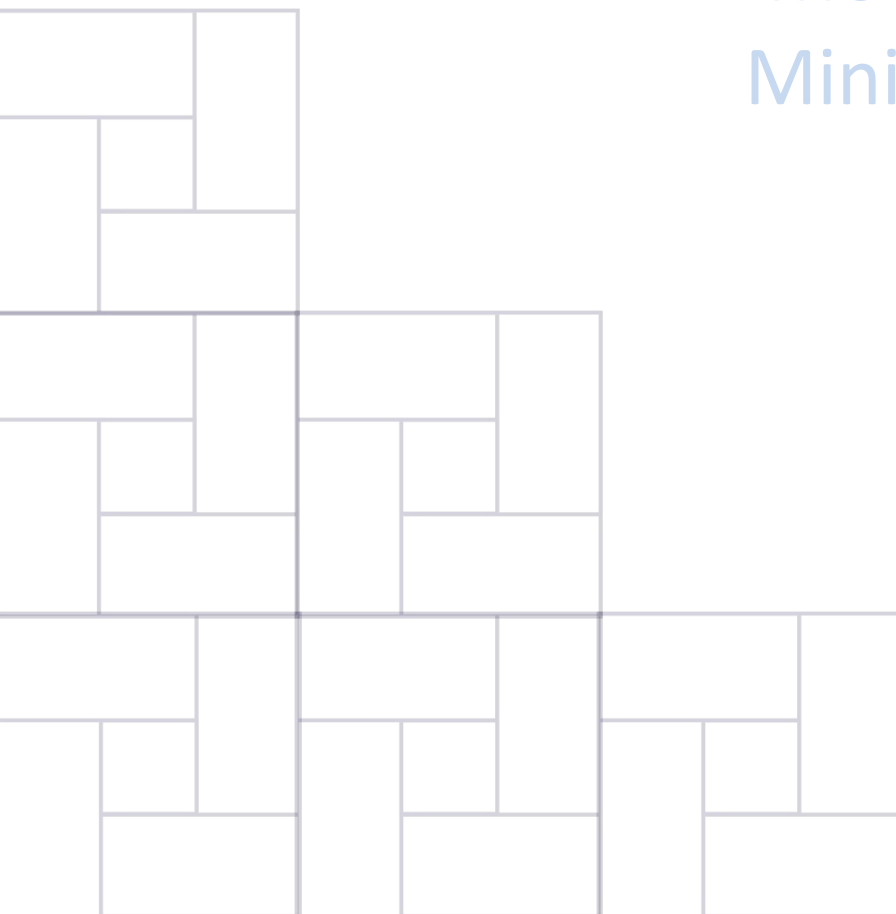

## PRÉ-MOLDADOS MESAS COM BANCO

### MSQB-L

Mesa quadrada com base para sobrepor no piso.

### MSQB-X

Mesa quadrada, com tabuleiro de xadrez em pastilhas e base para sobrepor no piso.

### MSQB-PI

Mesa quadrada, com tabuleiro de xadrez pintado e base para sobrepor no piso.

### MSQB-10

Banquinho quadrado para as mesas tipo MQB.

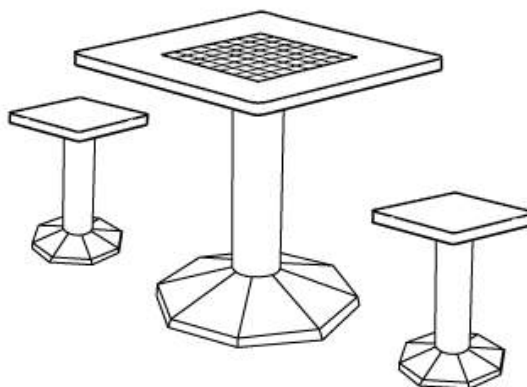

## MSQB-L

MEDIDAS: 80 x 82 x 6 cm  
PESO: 151 kg  
TAMPO: LISO

## MSQB-X

MEDIDAS: 80 x 82 x 6 cm  
PESO: 151 kg  
TAMPO: XADREZ C/ PASTILHA

## MSQB-PI

MEDIDAS: 80 x 82 x 6 cm  
PESO: 151 kg  
TAMPO: XADREZ PINTADO

## MSQB-10

MEDIDAS: 29 x 51 x 5 cm  
PESO: 20 kg

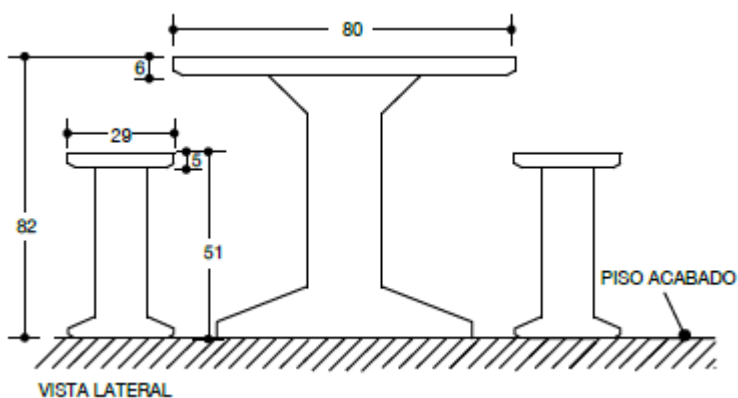

(\* ) Todos os campos são arredondados

## PRÉ-MOLDADOS MESAS COM BANCO

### MSRB-L

Mesa redonda, com base para sobrepor no piso.

### MSRB-X

Mesa redonda, com tabuleiro de xadrez em pastilhas e base para sobrepor no piso.

### MSRB-PI

Mesa redonda, com tabuleiro de xadrez pintado e base para sobrepor no piso.

### MSRB-10

Banquinho redondo para as mesas tipo MRB com base para sobrepor no piso.

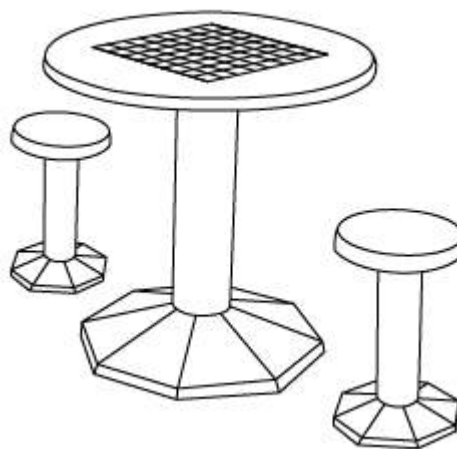

## MSRB-L

MEDIDAS: 80 x 82 x 6 cm  
PESO: 126 kg  
TAMPO: LISO

## MSRB-X

MEDIDAS: 80 x 82 x 6 cm  
PESO: 126 kg  
TAMPO: XADREZ C/ PASTILHA

## MSRB-PI

MEDIDAS: 80 x 82 x 6 cm  
PESO: 126 kg  
TAMPO: XADREZ PINTADO

## MSRB-10

MEDIDAS: 29 x 51 x 5 cm  
PESO: 19 kg

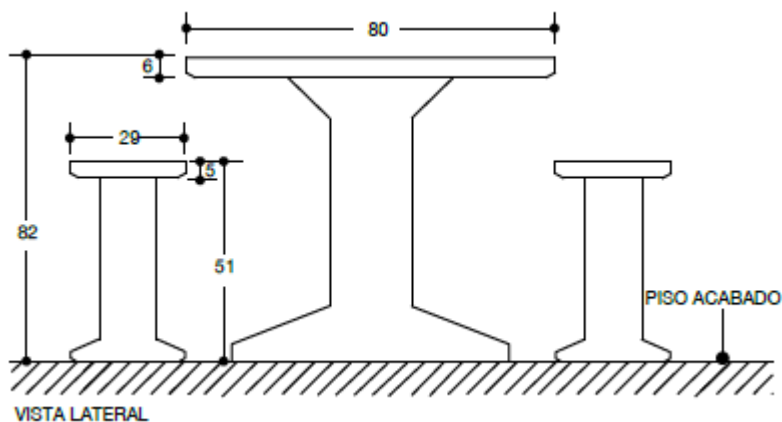

(\* ) Todos os campos são arredondados



## PRÉ-MOLDADOS MESAS COM BANCO

Conjunto de mesa e banquetas quadradas de concreto com ferragem, com tampo liso, tabuleiro de xadrez em pastilha ou pintado.

OBS: Itens podem ser adquiridos separadamente.

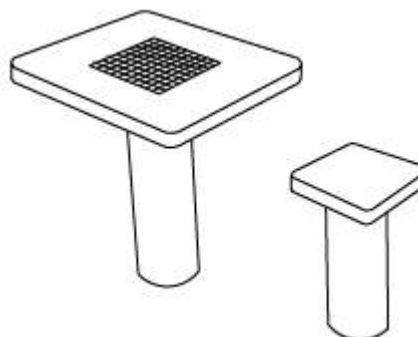

### MSQ

MEDIDAS: 90 x 95 x 5 cm  
PESO: 167 kg  
TAMPO: LISO

### MSQ-X

MEDIDAS: 90 x 95 x 5 cm  
PESO: 167 kg  
TAMPO: XADREZ C/ PASTILHA

### MSQ-PI

MEDIDAS: 90 x 95 x 5 cm  
PESO: 167 kg  
TAMPO: XADREZ PINTADO

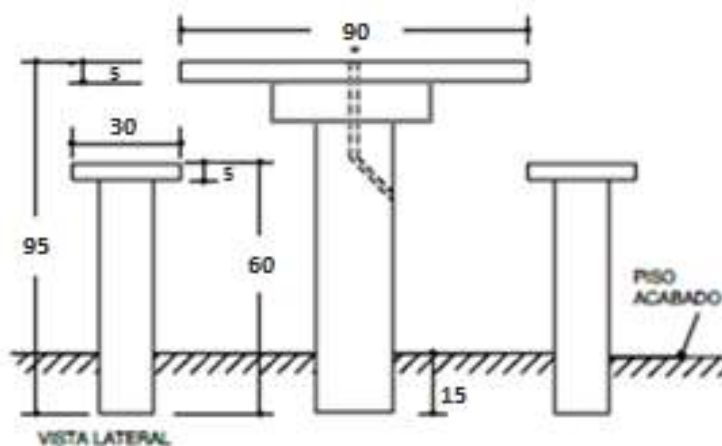

## PRÉ-MOLDADOS MESAS COM BANCO

Conjunto de mesa e banquetas redondas de concreto com ferragem, com tampo liso, tabuleiro de xadrez em pastilha ou pintado.

OBS: Itens podem ser adquiridos separadamente.

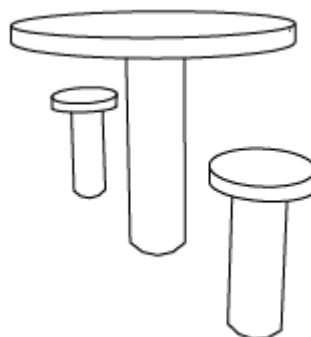

### MSR-L

MEDIDAS: 90 x 95 x 5 cm  
PESO: 171 kg  
TAMPO: LISO

### MSR-X

MEDIDAS: 90 x 95 x 5 cm  
PESO: 171 kg  
TAMPO: XADREZ C/PASTILHA

### MSR-PI

MEDIDAS: 90 x 95 x 5 cm  
PESO: 171 kg  
TAMPO: XADREZ PINTADO

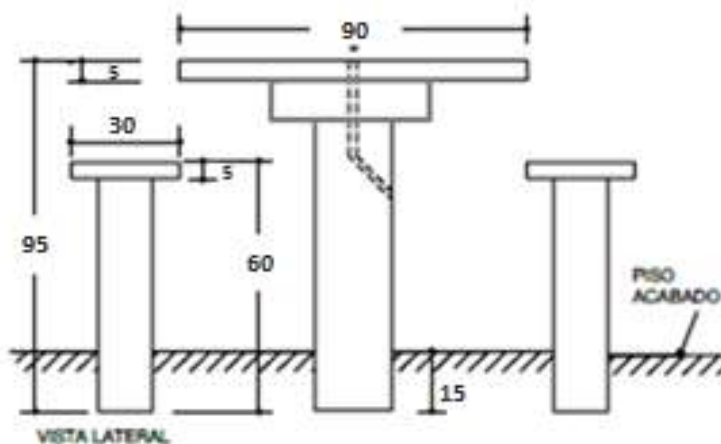



## PRÉ-MOLDADOS

Caixa para ar-condicionado 44

Bancos 47

Mesas com bancos 53

Grelhas e canaletas 58

Mourões 62

Miniguias 65

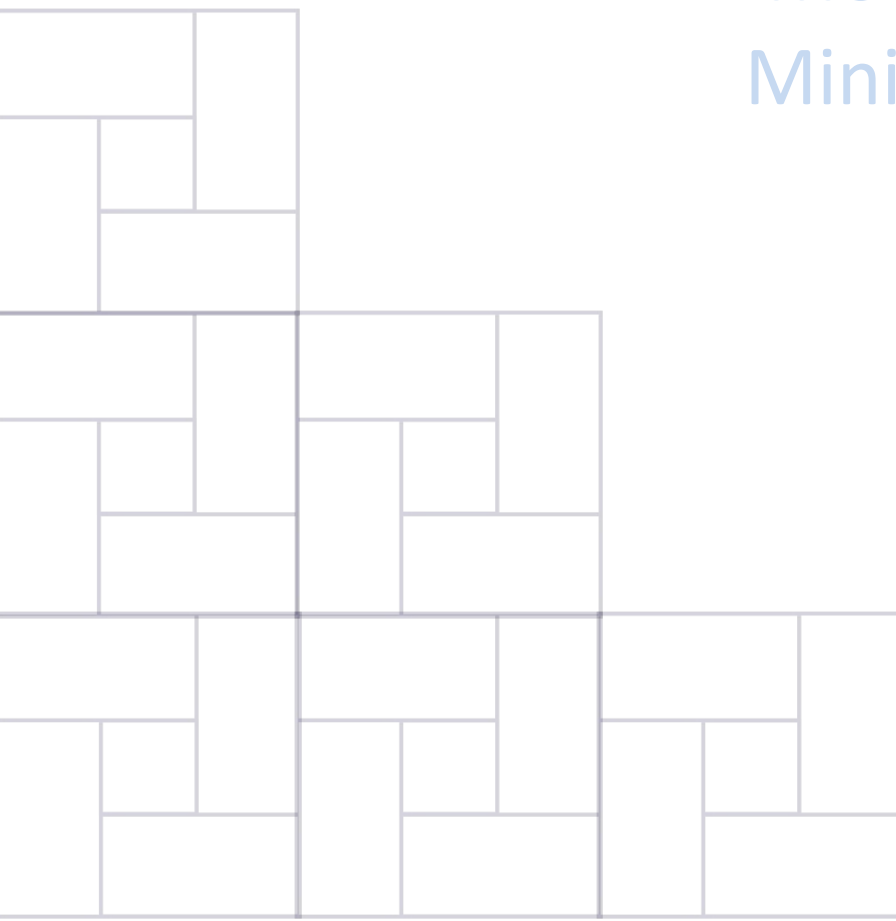

## PRÉ-MOLDADOS GRELHAS E CANALETAS

### GRF-1 / GRF-2

Grelha pré-moldada,  
acabamento liso, fundida - com  
10 furos com 5 cm de diâmetro.

### GRF-3

Grelha pré-moldada,  
acabamento liso, fundida - com  
15 furos com 5 cm de diâmetro.

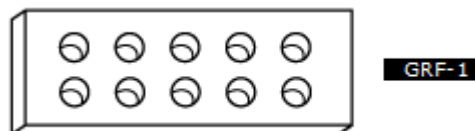

GRF-1

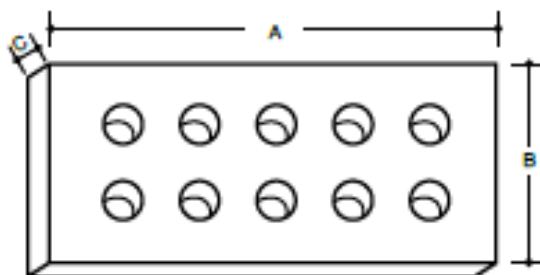

GRF-2

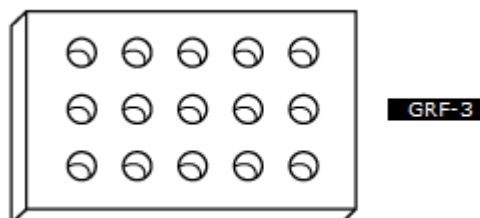

GRF-3

### GRF-1

MEDIDAS: 59,5 x 19,5 x 5 cm  
PEÇAS POR METRO LINEAR: 1,67  
PESO: 12 kg  
CONCRETO COM OU SEM FERRAGEM

### GRF-2

MEDIDAS: 59,5 x 24,5 x 5 cm  
PEÇAS POR METRO LINEAR: 1,67  
PESO: 14 kg  
CONCRETO COM OU SEM FERRAGEM

### GRF-3

MEDIDAS: 59,5 x 34,5 x 5 cm  
PEÇAS POR METRO LINEAR: 1,67  
PESO: 20 kg  
CONCRETO COM OU SEM FERRAGEM

## PRÉ-MOLDADOS GRELHAS E CANALETAS

Grelha pré-moldada, acabamento liso, fundida - com 14 furos com 5 cm de diâmetro.

### GRF-4

MEDIDAS: 59,5 x 40 x 5 cm  
PEÇAS POR METRO LINEAR: 1,67  
PESO: 24 kg  
CONCRETO COM OU SEM FERRAGEM

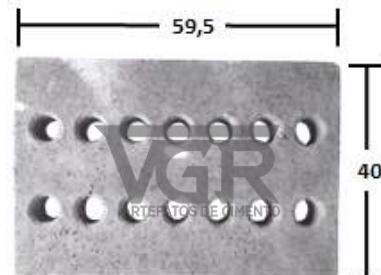

Vista Frontal

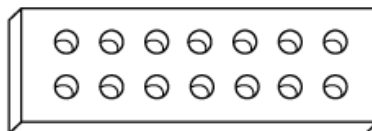

GRF-4

## PRÉ-MOLDADOS GRELHAS E CANALETAS

Porta grelha e canaleta pré-moldada para encaixe perfeito de grelha.

### CN-1

MEDIDAS: 60 x 30 x 7 cm  
PEÇAS POR M<sup>2</sup>: 13  
PESO: 4,3 kg  
ARGAMASSA PRENSADA

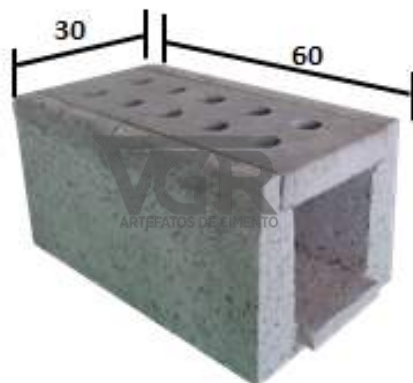

(\*)



(\*) Grelhas vendidas separadamente.

## PRÉ-MOLDADOS GRELHAS E CANALETAS

GRL-1: Grelha de concreto com ferragem, 10 lâminas.

GRL-2: Grelha de concreto com ferragem, 8 lâminas.

GRL-3: Grelha de concreto com ferragem, 8 lâminas.



### GRL-1

MEDIDAS: 60 x 30 x 5 cm  
PESO: 14 kg

### GRL-2

MEDIDAS: 60 x 30 x 8 cm  
PESO: 28 kg

### GRL-3

MEDIDAS: 60 x 50 x 5 cm  
PESO: 28 kg

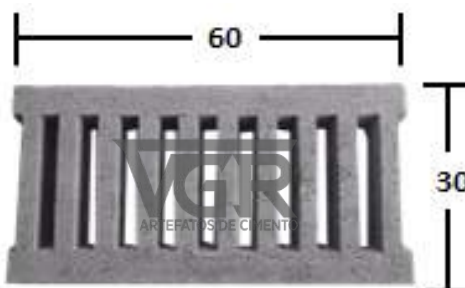



## PRÉ-MOLDADOS

---

Caixa para ar-condicionado 44

Bancos 47

Mesas com bancos 53

Grelhas e canaletas 58

Mourões 62

Miniguias 65

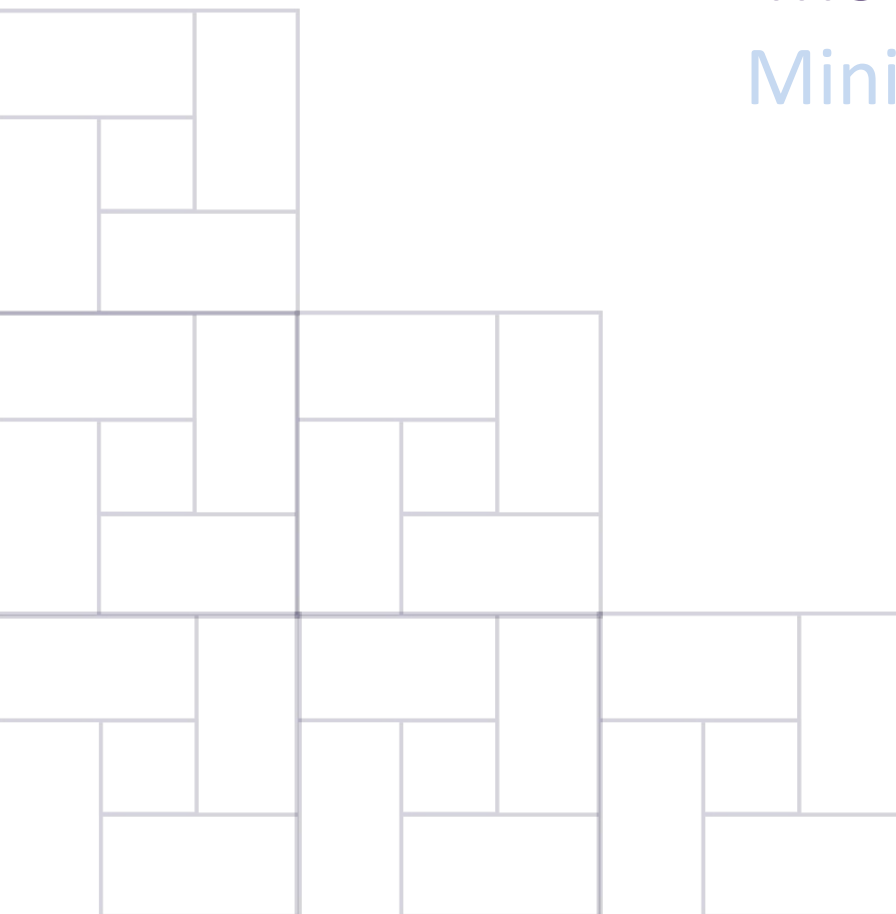



## PRÉ-MOLDADOS MOURÕES

Mourão em concreto com ferragem, formato triangular.

### MOURÃO01

MEDIDAS: A13 x B04 x C220 cm  
PESO: 84 kg

### MOURÃO02

MEDIDAS: A11 x B03 x C200 cm  
PESO: 50 kg



MD3G

MD3P

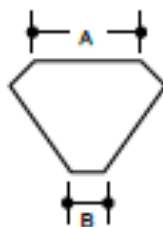

MD3G

MD3P

Vista Superior

Vista Lateral

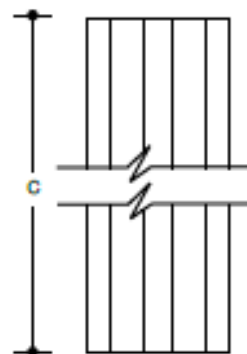

Sugestão de colocação

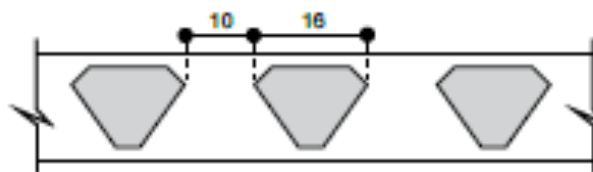

MD3P

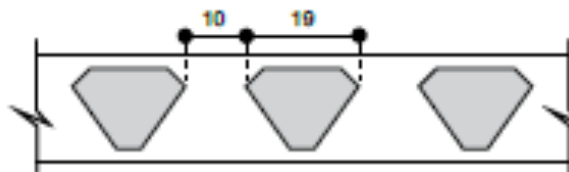

MD3G

## PRÉ-MOLDADOS MOURÕES

Mourão em concreto com  
ferragem, formato  
tipo L.

### MOURÃO3

MEDIDAS: 20 x 20 x 250 cm  
PESO: 128 kg

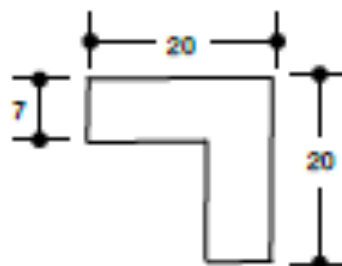

VISTA SUPERIOR

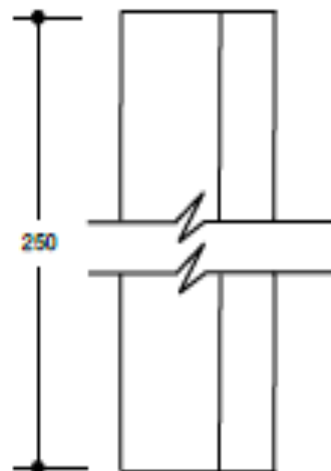

VISTA LATERAL

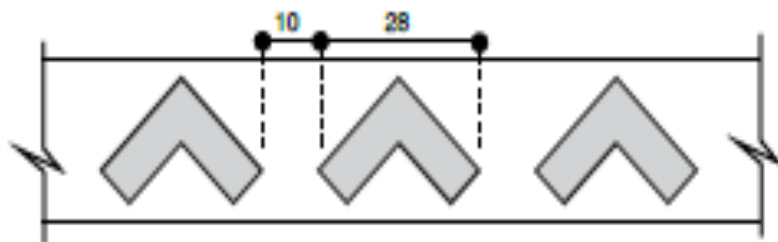

SUGESTÃO DE COLOCAÇÃO



## PRÉ-MOLDADOS

Caixa para ar-condicionado 44

Bancos 47

Mesas com bancos 53

Grelhas e canaletas 58

Mourões 62

Miniguias 65



## PRÉ-MOLDADOS MINIGUIAS

Mini guias em concreto para arremates e acabamentos.

### MG

MEDIDAS: 19 x 39 x 7 cm  
PEÇAS POR METRO LINEAR: 2,5  
PESO: 14 kg  
CONCRETO

### MG02

MEDIDAS: 19 x 80 x 7 cm  
PEÇAS POR METRO LINEAR : 1,25  
PESO: 28 kg  
CONCRETO



Usos gerais :

- (\*) Arremates de calçadas e pisos.
- (\*) Acabamentos de jardins..
- (\*) Travamentos de concregramas.



# LINHA ECOLÓGICA

Concregramas 67

Placa para Pisos 70

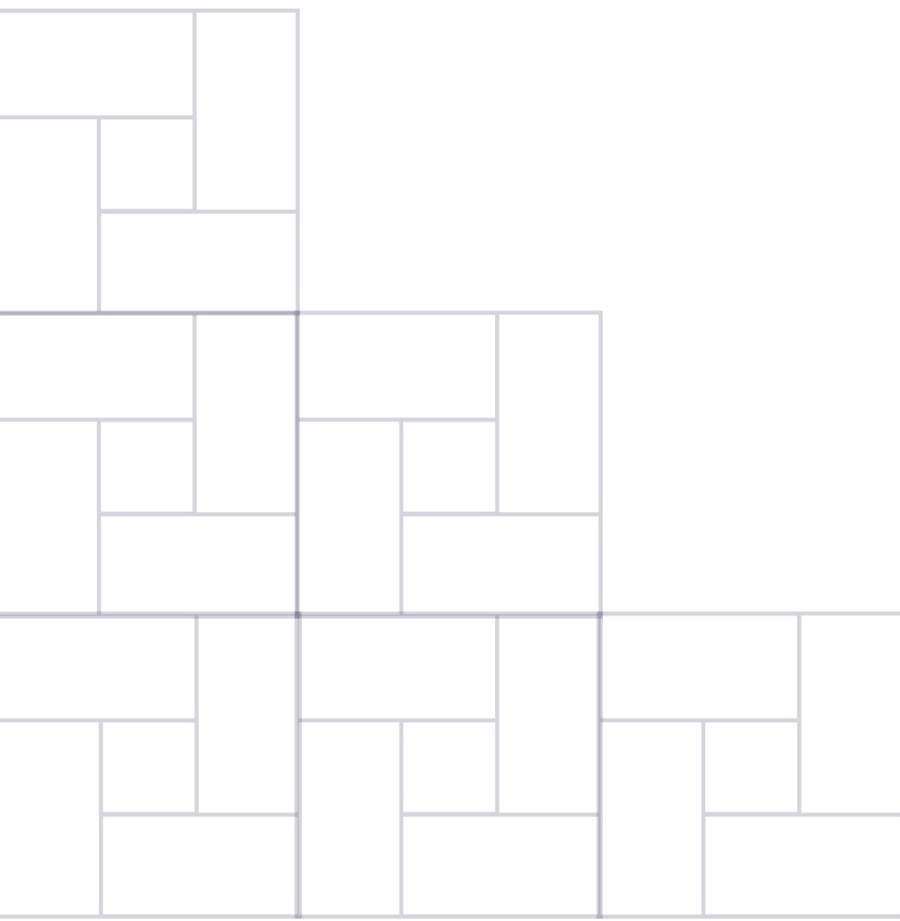

## LINHA ECOLÓGICA CONCREGRAMAS

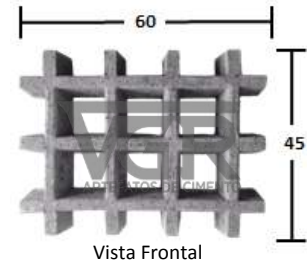

Concregrama em concreto para plantio de grama ou aplicação de outras matérias.

### CG07

MEDIDAS: 60 x 45 x 7 cm  
PEÇAS POR M<sup>2</sup>: 3,7  
PESO: 19 kg  
CONCRETO VIBRADO

### CG09

MEDIDAS: 60 x 45 x 9,5 cm  
PEÇAS POR M<sup>2</sup>: 3,7  
PESO: 25 kg  
CONCRETO VIBRADO

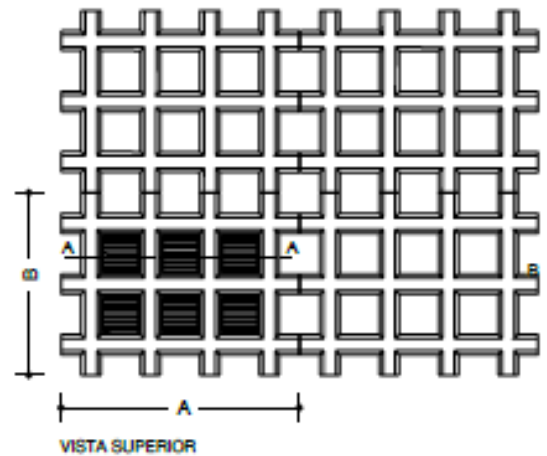
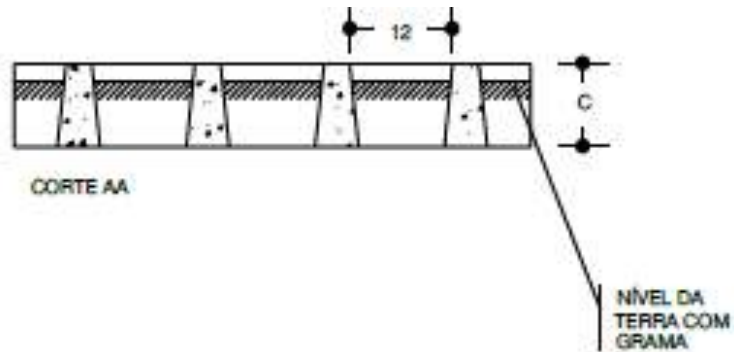

- (\*) Cobertura integral pela grama.
- (\*) Aparência de parque.
- (\*) Colocação:
  - Compactar e nivelar o solo;
  - Preparar uma camada de 2cm de areia grossa;
  - Dispor as peças bem alinhadas;
  - Colocar a terra;
  - Plantar a grama.
- (\*) Grama sugerida: esmeralda.
- (\*) Resistência do concreto: 25MPs

## LINHA ECOLÓGICA CONCREGRAMAS

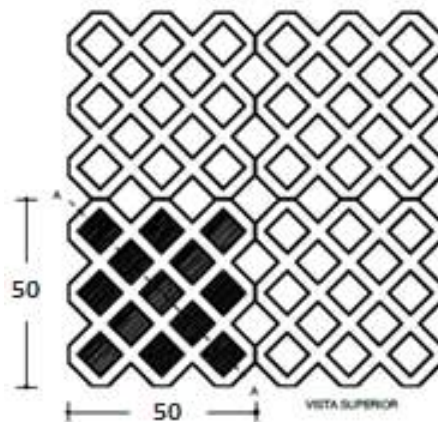

Concregrama em concreto para plantio de grama ou aplicação de outras matérias.

**CGD9**

MEDIDAS: 50 x 50 x 9,5 cm  
PEÇAS POR M<sup>2</sup>: 4  
PESO: 28 kg  
CONCRETO VIBRADO

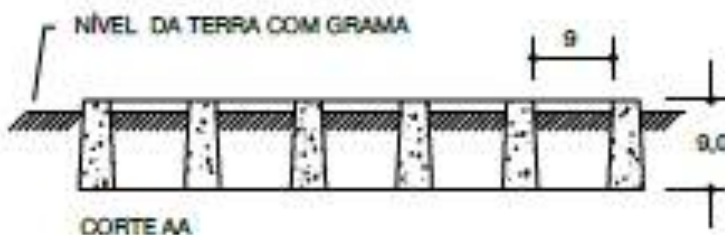

(\* Bom para caminhar.

(\* Fácil colocação.

(\* Colocação:

- Compactar e nivelar o solo;
- Preparar uma camada de 2cm de areia grossa;
- Dispor as peças bem alinhadas;
- Colocar a terra;
- Plantar a grama.

(\* Grama sugerida: esmeralda.

(\* Resistência do concreto: 25MPs





# LINHA ECOLÓGICA

Concregramas 66

Placa para Pisos 70

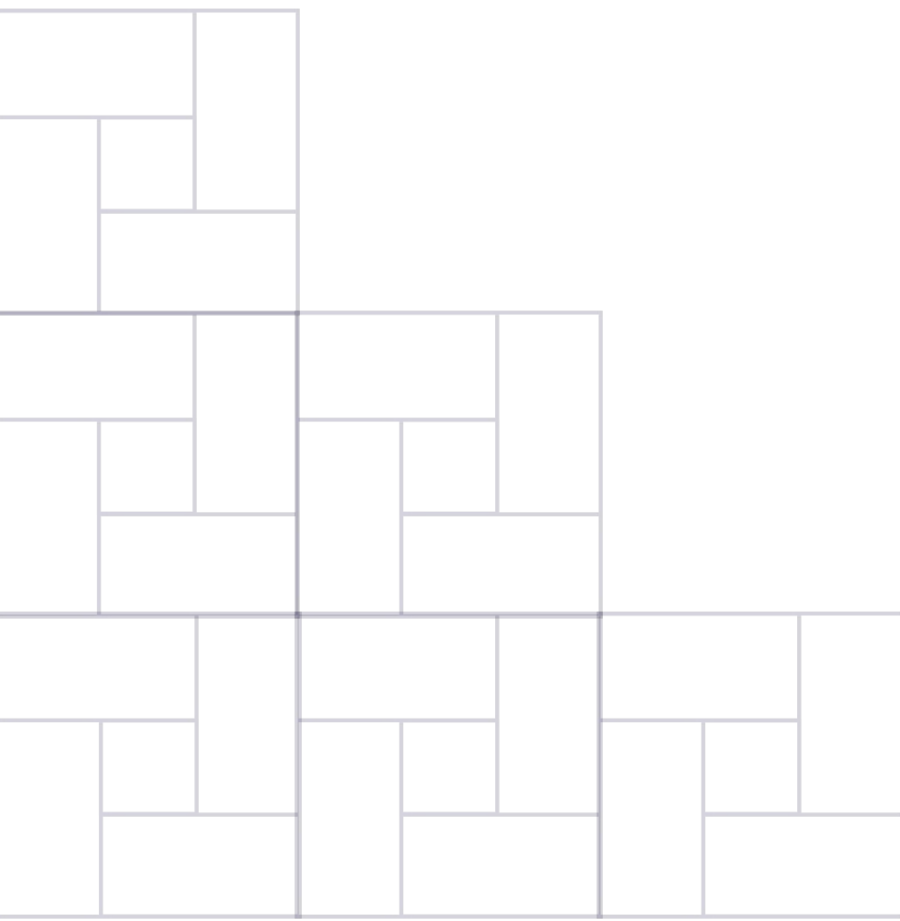

## LINHA ECOLÓGICA PLACAS PARA PISOS



Placa para piso de concreto com ou sem ferragem.

OBS: medidas podem ser alteradas de acordo com a necessidade do projeto.

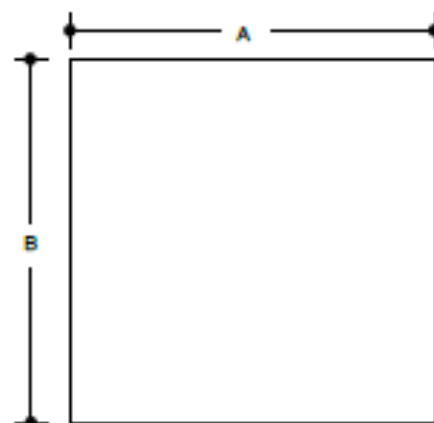

VISTA FRONTAL

### PP40

MEDIDAS: 40 x 40 x 5 cm  
PEÇAS POR M<sup>2</sup>: 6,3  
PESO: 17 kg

CONCRETO COM OU SEM FERRAGEM

### PP50

MEDIDAS: 50 x 50 x 5 cm  
PEÇAS POR M<sup>2</sup>: 4  
PESO: 30 kg

CONCRETO COM OU SEM FERRAGEM

### PP60

MEDIDAS: 60 x 60 x 5 cm  
PEÇAS POR M<sup>2</sup>: 2,8  
PESO: 37,5 kg

CONCRETO COM OU SEM FERRAGEM

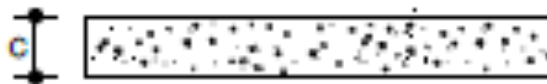

CORTE AA

(\*) Placas antiderrapantes para áreas externas.

(\*) Podem ser utilizadas para caminhos em gramados ou sobre contrapiso, sendo uma excelente alternativa técnica e econômica para pisos externos e calçadas.

(\*) Acabamento rústico.

(\*) Fabricamos as peças sob medida podendo ser ajustadas nas medidas solicitadas



## **PRODUTOS DIVERSOS**

Capas para muros 72

Pingadeiras 72

Chapim 72

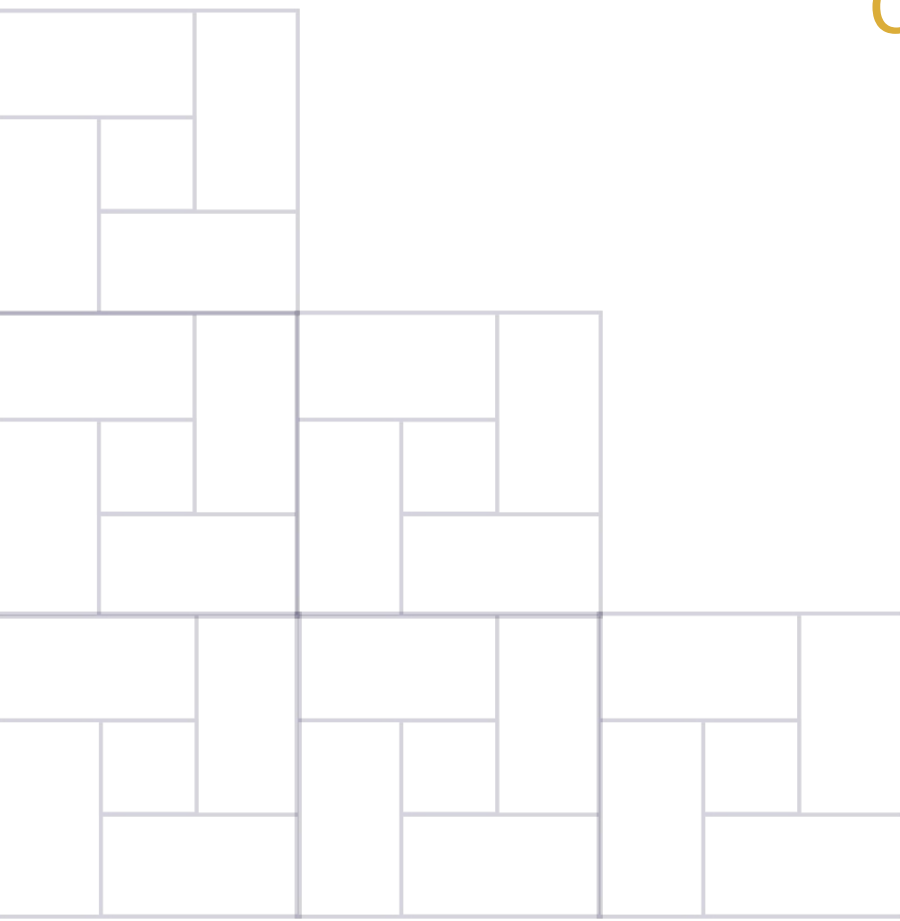

## PRODUTOS DIVERSOS

### CAPAS PARA MUROS/PINGADEIRAS/CHAPIM

Capa para sobreposição em muros.

**19**

**MEDIDAS:** 10 x 50 x 14 cm  
**PEÇAS POR METRO LINEAR:** 2  
**PESO:** 3,6 kg  
**ARGAMASSA PRENSADA**

**19A**

**MEDIDAS:** 14 x 50 x 18,5 cm  
**PEÇAS POR METRO LINEAR:** 2  
**PESO:** 5 kg  
**ARGAMASSA PRENSADA**

**19B**

**MEDIDAS:** 19 x 40 x 24 cm  
**PEÇAS POR METRO LINEAR:** 2,5  
**PESO:** 5 kg  
**ARGAMASSA PRENSADA**

**19C**

**MEDIDAS:** 16 x 50 x 20 cm  
**PEÇAS POR METRO LINEAR:** 2  
**PESO:** 5 kg  
**ARGAMASSA PRENSADA**



CHAPIM



Vista Frontal

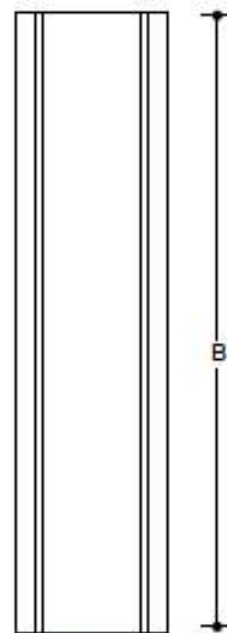

VISTA INFERIOR